

Manual ProLine+



1. Index

1. Index	2
2. Important safety instructions	4
2.1.Safety	4
2.2.Placement	4
2.3.Repair	5
2.4.Environment	5
2.5.Recycling and disposal	6
Packaging	6
Device	6
Batteries	6
3. Installation	7
3.1.Place of installation	7
3.2.Cabling	8
4. At first glance	9
4.1. Product Specifications	9
4.2. Package contents	11
4.3. Product overview	13
4.4. Touchscreen control	15
4.5. Control Panel Buttons	16
4.6. Microphone	17
4.7. The ProLine+ logo	17
4.8. Install the PC module	18
4.9.Cleaning	20
5. ProWrite® Ink technology	21
5.1. De ProWrite® Ink pen	22
5.2. ProWrite® Ink pen charging station	23
5.3. ProWrite® Ink technology necessities	24
6. Getting started	24
6.1. Turn the touchscreen on and off	24
6.2. Starting your device for the first time	26
6.3. Connect to a network	28
6.4. Adjust volume	29
7. Prowise Central	30
7.1.Prowise Central home	30
7.2.The Prowise Central menu	31
8. Adjust settings	32

8.1. Display	32
8.2. Audio	33
8.3. Connectivity	33
8.4. General settings	35
8.5. Input	37
8.6. On/Off	38
9. OTA (Over The Air) updates	39
10. Remote control	40
10.1. Schematic view and explanation of the buttons	40
10.2. Angle at which remote control is used	42
10.3. Inserting the batteries	43
11. Connect peripherals	44
11.1. Connect the ProLine+ Multi-touchscreen to an external PC	44
11.1.1. Connect using a HDMI cable	44
11.1.2. Connect using a DP cable	45
11.2. Connecting the ProLine+ Multi-touchscreen to audio equipment	46
11.2.1. Connecting headphones:	46
11.2.2. Connecting an amplifier	47
11.2.3. Connecting using the HDMI port (ARC):	48
11.2.4. Connecting using the HDMI port (CEC)	49
Appendix	50
RS232 Protocol and Code list	50
Protocol Description	51
RS232 Code list	51

2. Important safety instructions



WARNING! Before using the ProLine+ multi-touchscreen, please read this user manual and the safety instructions (separate document) carefully. Follow the warnings stated on the device, the user manual and the safety instructions. Always keep the safety instructions and the user manual within reach.

2.1.Safety

- Never open the housing of the touchscreen! You can get an electric shock or cause a short circuit.
- Do not use the touchscreen during thunder storms and unplug the power cable to avoid damage due to a lightning strike.
- Make sure your touchscreen does not get wet! This could lead to short circuiting and electrocution hazard. Do not install the device close to water and do not place objects containing liquid on- or next to it.
- Excessive sound volume causes permanent hearing damage. If the device is used at high sound volume for an extended period of time, this can cause hearing damage to the listener.
- Only use components and accessories supplied by Prowise.
- Always turn off the touchscreen and unplug it from the electrical outlet when changing a module.
- Do not insert any device other than the ProWrite Ink pen in the charging station on the right hand side of the touchscreen. Inserting other objects may damage the charging station and the touchscreen.

2.2.Placement

- We recommend you don't install the touchscreen yourself or by a third party. Let Prowise or a certified Prowise partner install or mount the touchscreen to avoid possible damage. Prowise can not be held responsible for any damage or injury caused by incorrect installation by third parties. Damage due to incorrect installation by third parties will not be covered by the warranty.
- Do not install or place the touchscreen onto an unstable surface.
- Do not use the touchscreen in an industrial environment where it will frequently get exposed to vibrations and dust.

- Do not place the touchscreen close to equipment that generates heat.
- Make sure that all ventilation openings, located at the back of the touchscreen, stay uncovered, so hot air can escape.
- Only connect the touchscreen to an earthed electrical socket.

2.3.Repair

Never repair the touchscreen yourself!



WARNING! *Warning for electrified parts! Never open the housing of the touchscreen! You can get an electric shock, cause a short circuit or even a fire. This can cause injuries or damage to yourself and/or the touchscreen.*

Always contact Prowise or a certified partner in case of a defect, to avoid damage.

2.4.Environment

- Unplug the power cable if the screen will not be used for an extended period.
- The power consumption in standby mode is <0.5 watts.
- When the touchscreen is no longer usable, it can be disposed of at a designated collection point.



PLEASE NOTE! *When WOL and WOS are activated, the power consumption in standby mode will increase!*

2.5. Recycling and disposal

If you have questions about the correct disposal of your touchscreen, please contact Prowise or a certified partner.



Packaging

The device is packaged to prevent transport damage. Packaging consists of resources that can be reused or recycled.



Device

Do not dispose of the device with household waste at the end of its lifespan. Ask about the possibilities for an environmental friendly and responsible method of disposal.



Batteries

Depleted or defective batteries do not belong in the household waste. Dispose of them at a collection point for empty batteries. The remote control uses 1.5V AAA batteries.

3. Installation

A Prowise certified mechanic will install the Pro Line+ Multi-touchscreen on delivery and will ensure the screen is ready for use. We do not recommend it, however if you want to install the screen yourself or by someone else, then please follow the following steps:

- Do not install the touchscreen alone.
- Use a certified Prowise wall bracket when assembling a wall lift or mobile lift.
- Please ensure the wall is strong enough to carry the weight of the touchscreen.
- Connect the cables (which cables you require depend on the external devices you use or other external sources like a lift system).
- If you are using a PC module, ensure the module is inserted and tightened correctly. Install the PC module as described in the chapter 'Install PC module'.
- Make sure to only connect the power cable when the above elements have been connected.



CAUTION! *Prowise can not be held responsible for any damage or injury caused by the incorrect installation of the touchscreen done by third parties. Damage to the touchscreen, caused by incorrect installation by third parties, will not be covered by the warranty. Always contact Prowise or a certified partner if you have any questions about the installation.*

3.1. Place of installation

Please follow the instructions below, these will help guarantee reliable functioning and a long lifespan of your touchscreen.

Keep the touchscreen and all connected devices away from moisture and avoid dust and heat. Do not place the touchscreen near devices which produce heat or in the vicinity of water. Non-compliance with these instructions can lead to faults or damage to the touchscreen.

The ProLine+ multi-touchscreen can be used at an ambient temperature from 0 °C to +38 °C (32 °F to 100,4 °F) and relative humidity from 10% to 90% (without condensation).

When switched-off, the touchscreen can be stored at a temperature from -20 °C to 60 °C (-4 °F to 140 °F) and relative humidity from 10% to 90% (without condensation).

Install the touchscreen on a stable, vibration-free surface/wall to avoid damage to the touchscreen. Make sure that all of the ventilation openings, located at the back of the screen, stay uncovered, so hot air can escape.



WARNING! *Disconnect the power cable during a thunderstorm. For extra safety, we recommend using an overvoltage protection device, to prevent the touchscreen from sustaining damage as a result of power surges or lightning strikes.*

3.2.Cabling

Only use the power cable supplied by Prowise to connect the ProLine+ Multi-touchscreen to the mains power supply. The touchscreen must be placed close to the electrical outlet and the electrical outlet should be easy to reach. Cables should not be laid in the walkway to avoid anyone stepping on them or tripping over them. Do not place any objects on the cables to avoid damaging them. Prevent electrical overloads when using a distributing plug, as this can lead to a short circuit.

For extra safety, we recommend using an overvoltage protection device to prevent the touchscreen from sustaining damage as a result of power surges or lightning strikes.



CAUTION! *Only plug the power cable into grounded electrical outlets with AC 100-240V ~50/60Hz. If you are not sure about the power supply at the installation location, consult your energy company.*

4. At first glance

We recommend you not to install the touchscreen yourself or by a third party. Have Prowise or a certified partner install or mount your touchscreen, to avoid possible damage.

Always adjust the screen to the correct height before use. Avoid standing in a stooped or bent posture and ensure that the ends of the screen are located within arm's reach.

In the optimal position of the screen, you can touch both the top and bottom of the screen without needing to stoop or reach far up. By positioning the screen properly, you can avoid physical problems that could result from an incorrect work posture. Avoid physical complaints caused by a poor posture.



DANGER! Risk of injury. Do not stand on a chair, stool or other object to operate the touchscreen. This especially applies to children! This involves a risk of falling that could result in serious injury. Ensure that the screen is installed at the correct height or that the lift is set to the correct height when the screen is used.

4.1. Product Specifications

Panel type	Ultra HD LED (4K)
Resolution	3840 x 2160 @ 60Hz
Screen size	65" 75"
Glass thickness	4 mm/0.16 inches anti-glare pro
Aspect ratio	16:9
Viewing angle	178°
Glass hardness	Mohs 7
Touch module	IR pro
OS (touch module)	Windows 7, 8, 8.1 & 10/Linux /Mac OS/Android/Chrome OS

Multi-touch	20-points touch
Multi-writing	10 points
Auto-calibration	Yes
Resistant to sunlight	Yes
Speakers	10W (front/tweeter) x 2 + 10W (Bass spk) x 2
Microphone	Yes, wide-area
ProWrite Ink pen	Yes, Wide-area
ProWrite Ink technology	EMR
Pressure sensitivity	2048 levels
Hoover function	Yes
Hand-palm rejection	Yes
Power supply	ProWrite Ink pen charging station (through induction)
PC module slot	Yes, OPS
WiFi	Yes
Connectivity	Intel AC-8265 (802.11ac, Dual Band 2.4 GHz & 5 GHz)
WiFi band	a/b/g/n/ac
Bluetooth	Bluetooth 4.2
Chipset	Rockchip
ARM	Cortex A53 Quad Core and A72 Dual Core CPU 64-bit
GPU	Quad Core Mali-T860 (MP4)
RAM capacity	4 GB
ROM Flash capacity	32 GB
LAN Port	10/100/1000Mbit
Certifications	CE: EMC – LVD, FCC + IC, RCM, ROHS, OHSA – UL
Warranty	7 year

4.2. Package contents

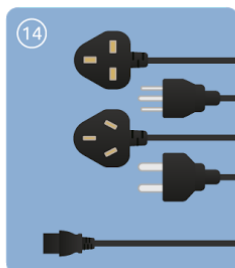
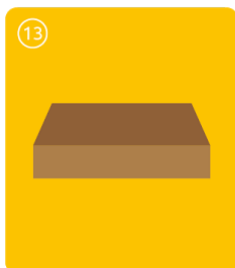
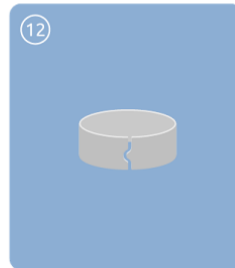
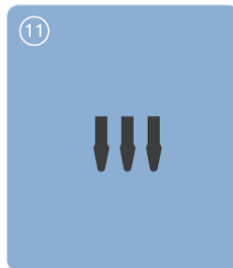
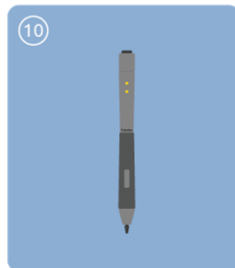
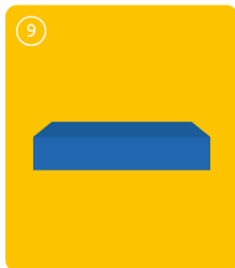
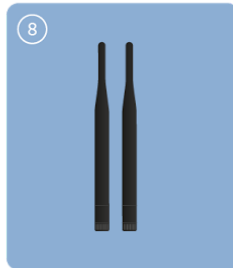
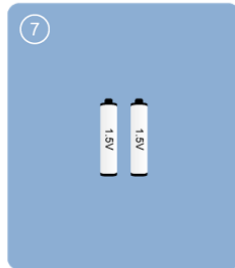

1. **ProLine+ Multi-touchscreen**
2. **Welcome box:**
3. Quick Start Guide
4. Safety instructions
5. Remote control
6. NFC card (2x)
7. 1.5V AAA batteries (2x)
8. WiFi antenna (2x)
9. **ProWrite Ink pen box:**
10. ProWrite® Ink pen
11. pentips (3x)
12. Pen tip removal tool
13. **Cardboard box:**
14. Power cable ~EU, UK, US and/or AUS



WARNING! *Keep the packaging material, such as plastic foil, out of reach from children. Improper use of packaging materials can result in a suffocation hazard.*



PLEASE NOTE! *Check that what has been supplied is complete and contact our service desk within 5 days of delivery if it is incomplete. Please provide the serial number and a copy of the invoice.*

4.3. Product overview

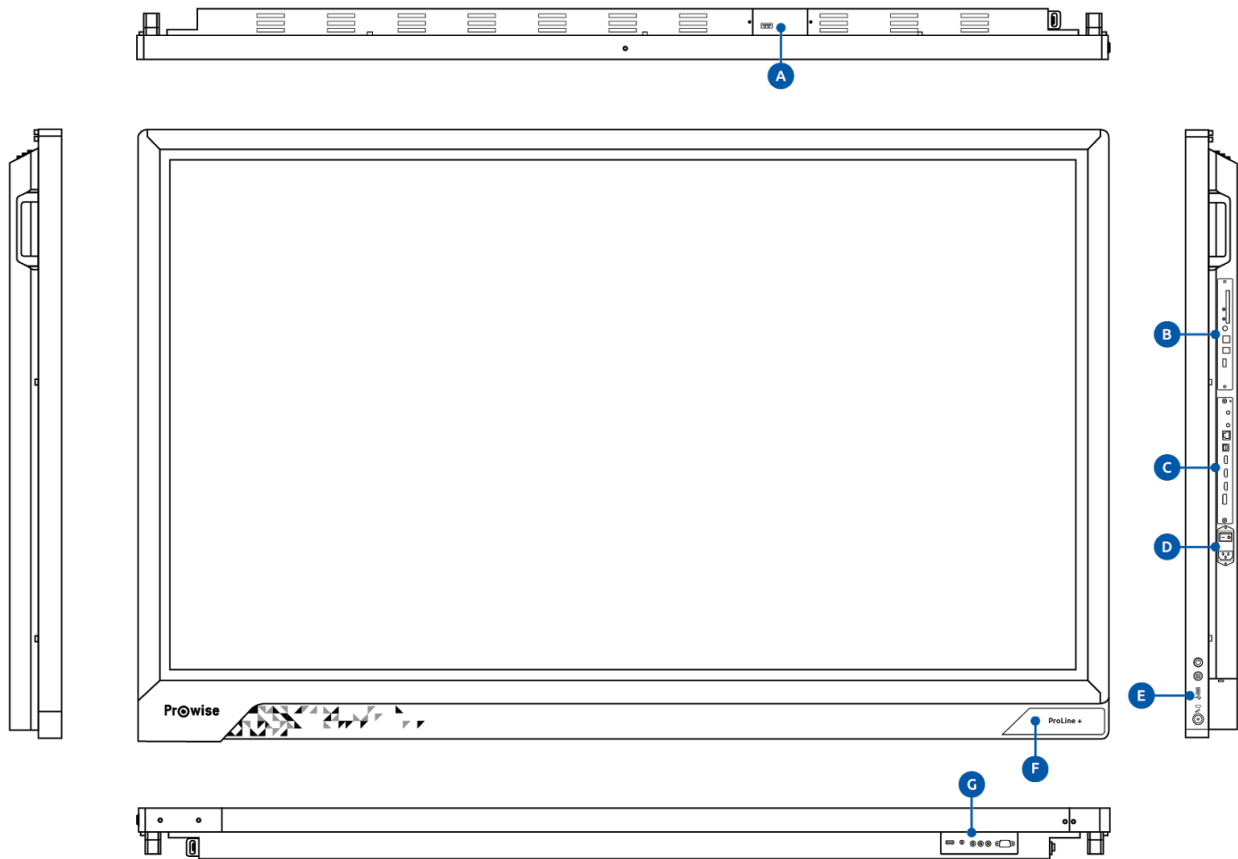

- A. USB 3.0 (for webcam)
- B. OPS slot
- C. External inputs
- D. AC-IN and Power switch
- E. Control panel and charging station
- F. IR sensor For remote control/led status light/NFC card reader
- G. External inputs/outputs

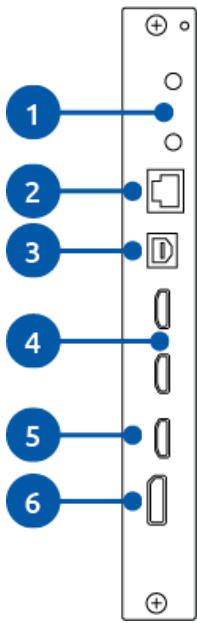

1. Wifi antenna ports
2. LAN port
3. USB-B port
4. HDMI 2.0 input ports (4K @ 60 Hz)
5. HDMI with ARC input (4K @ 60 Hz)
6. Displayport 1.2 (4K @ 60 Hz)

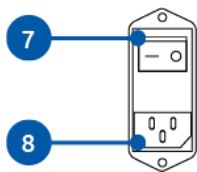

7. Power switch
8. AC IN

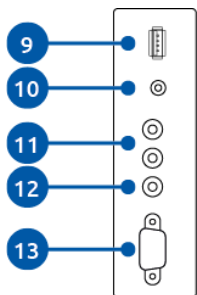

9. USB 2.0 (lift connection and service)
10. Analogue output headphones (audio)
11. Analogue audio output (L/R)
12. Digital Coax
13. RS232

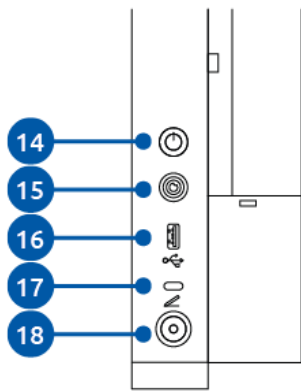



- 14. On/Off button
- 15. Prowise Central home button
- 16. USB 3.0
- 17. Status LED charging station
- 18. Charging station ProWrite Ink pen

4.4. Touchscreen control

The ProLine+ Multi-touchscreen is fitted with 20-points multi-touch. The screen recognises up to 20 simultaneous touchpoints. This allows you to use the touchscreen with multiple people at once.

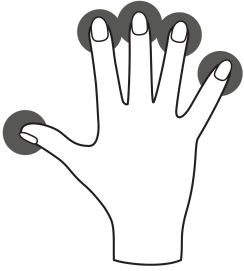
	<p>Click</p>	<p>To click on a part of the screen, gently tap with one finger on the touchscreen.</p>
	<p>Drag</p>	<p>Tap with one finger on the item that you want to move and drag it to the new location without releasing your finger from the screen.</p>

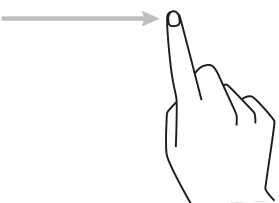
	<p>Open Prowise Central menu</p>	<p>Place five fingers of one hand on the screen for at least 2 seconds. The menu will appear.</p>
	<p>Right-click (context-menu) (PC module)</p>	<p>Tap and hold one finger on the screen for a few seconds for the right click function.</p>
	<p>Scroll</p>	<p>Slide one finger across the screen in the desired direction.</p>

The touchscreen can also be controlled by using a computer mouse or with the supplied remote control. Furthermore, you can use the buttons of the control panel, located on the right-hand side of the touchscreen, to turn off the touchscreen or to navigate back to the Central home environment.

4.5. Control Panel Buttons

The buttons below are found on the control panel on the right-hand side of the touchscreen.

On/Off button

- When the touchscreen is turned off, press this button to turn it back on again.
- When the touchscreen is turned on, press this button to turn it off.

Prowise Central button

- Press this button to navigate from a different input source back to the Prowise Central home environment.

4.6. Microphone

The ProLine+ Multi-touchscreen has a wide area microphone. Use the microphone if a PC module is installed or if the touchscreen is connected to an external PC. It is also possible to turn the microphone on and off in this environment.

4.7. The ProLine+ logo

The ProLine+ logo, on the right-hand side of the touchscreen, has various functions:

- Hold the NFC card in front of the logo to log in using NFC technology.
- The LED next to the ProLine+ logo indicates the touchscreen's status.
 - The touchscreen is turned on: Blue
 - Backlight is turned off: Blue
 - Sleep mode: Flashing red (every 2 seconds)
 - Standby mode: Red
- The remote control's IR sensor is located to the right of this logo.



PLEASE NOTE! *To log in with an NFC card, the card must first be configured using the Prowise Central settings menu.*

4.8. Install the PC module

Follow the steps below to install the PC module



CAUTION! Please ensure the power cable is not connected to the main power supply when installing the PC module.

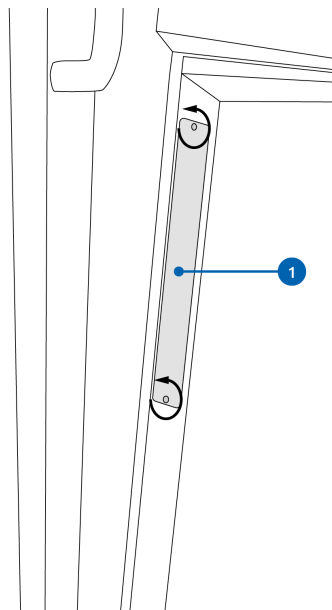

1. Unscrew the screws

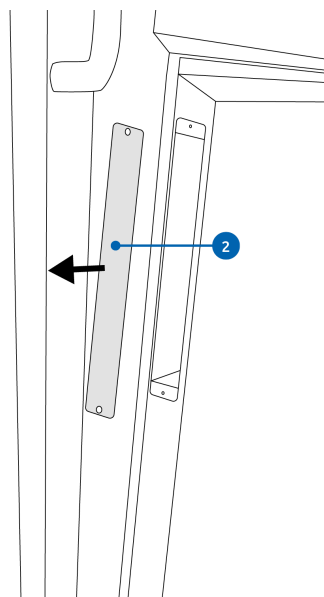

2. Remove the cover plate

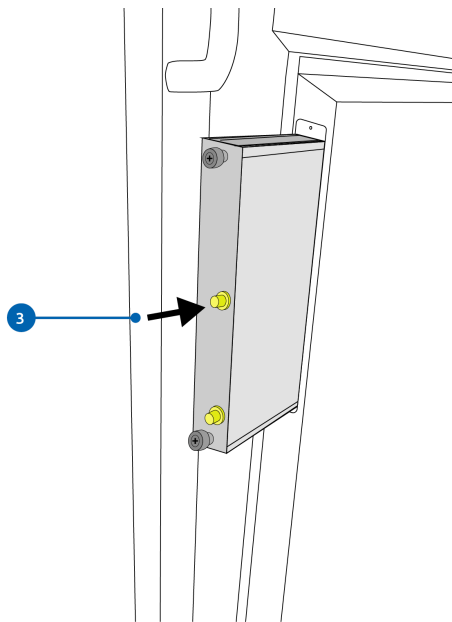

3. Insert the PC module into the slot

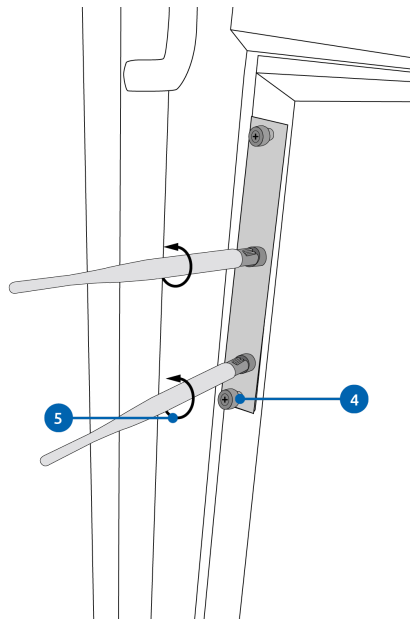

4. Tighten the lock screw of the PC module
5. Secure the WiFi antennas on the PC module

4.9. Cleaning

Clean the screen with a dry, lint-free, microfibre cloth. Ensure this cloth is free of impurities.

If you wish to use a cleanser, always use a cleanser recommended by Prowise. Do not use any aggressive cleansers as these can cause damage to the screen.

Never spray a cleanser directly onto the screen, apply it to a cloth first. The cloth may be slightly damp, but not wet, as this can cause damage to the screen.

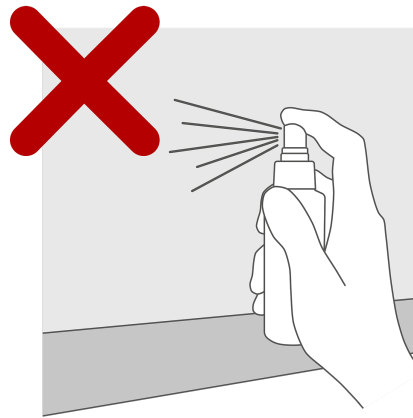
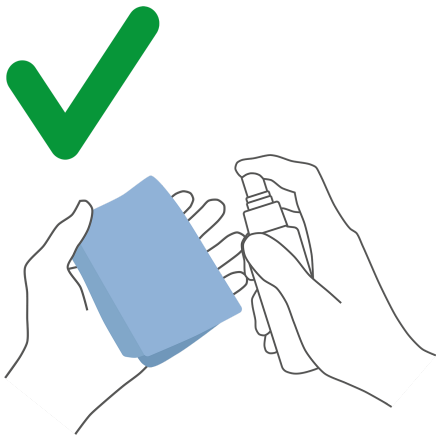

Gently wipe down the screen with the cloth. Clean the screen with gentle, circular movements without pressure to gain the best result. Never use an abrasive cleanser.

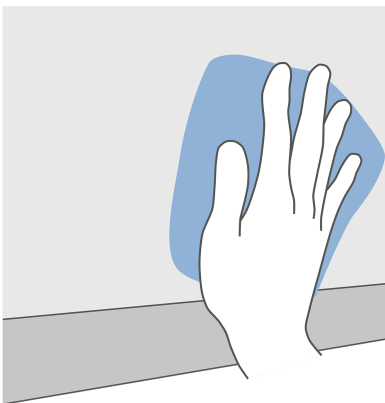



WARNING! *In the unlikely event that the touchscreen gets wet, do not turn the power on and do not insert the power cable into the electrical outlet. This can result in an electric shock. Should the touchscreen get wet when it's turned on, immediately turn off the power supply and disconnect the power cable of the touchscreen from the electrical outlet to avoid a short circuit.*



CAUTION! *Unplug the power supply before cleaning the screen.*

5. ProWrite® Ink technology

The ProLine+ Multi-touchscreen comes with a ProWrite® Ink pen to give the user a natural writing experience. The pen can be stored and charged in the charging station on the right-hand side of the touchscreen. Once charged, the pen can be used immediately. It does not have to be connected to the screen.

The ProWrite® Ink pen gives the user a natural writing experience. This is because it includes certain clever functions. For example, the ProWrite® Ink pen has a pressure-sensitive tip, which alters the thickness of the line you draw depending on the pressure exerted on the pen. The ProWrite® Ink technology also uses palm rejection. Thanks to the implementation of palm rejection, it is possible to rest your hand on the screen when writing without this having an influence on what is written or drawn on the screen. The ProWrite® Ink pen also has a hover function, which gives an immediate indication of where the writing or drawing will be located on the screen, allowing you to work more accurately.

5.1. De ProWrite® Ink pen

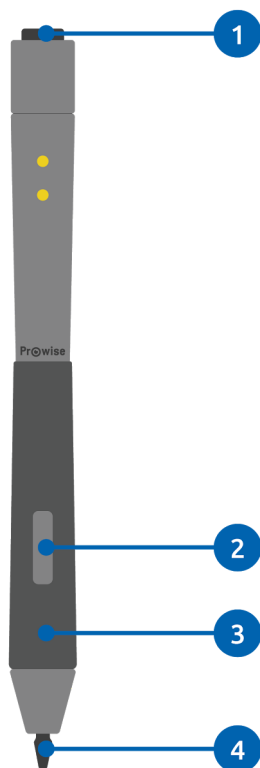

1. Erase
2. Right mouse button
3. Palm rejection
4. Pressure-sensitive tip

The charging station is a safe storage location for the ProWrite® Ink pen. The ProWrite® Ink pen will charge when placed in the charging station, even when the touchscreen is in standby mode.



PLEASE NOTE! *To ensure that palm rejection works correctly, the tip of the pen must first make contact with the touchscreen before you rest your hand on the screen when writing.*

5.2. ProWrite® Ink pen charging station

The ProWrite® Ink pen charging station is located on the right-hand side of the touchscreen. Place the pen in the charging station to charge it. The LED indicator light at the top of the charging station indicates the ProWrite® Ink pen's battery status.

Information about the LED indicator light on the charging station:

- Off: there is no pen in the charging station.
- Flashing red light: the pen is being charged.
- Lit green continuously: the pen is fully charged.

A fully charged pen can be used for approximately 10 hours. It takes 2-3 hours to fully charge the ProWrite® Ink pen.

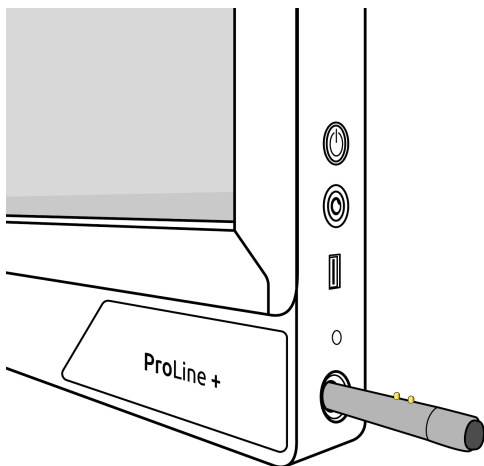

PLEASE NOTE! *The ProWrite® Ink pen protrudes approximately 1 cm when it is placed in the charging station. To avoid damage to the pen and the charging station, never try to push the pen all the way into the charging station.*



WARNING! *Only place the ProWrite® Ink pen in the charging station. Other objects may cause damage to the charging station and the touchscreen. Conductive objects, such as a metal pen, can cause a short circuit, which may damage or break the charging station.*

5.3. ProWrite® Ink technology necessities

Hardware:

- Prowise ProLine+ Multi-touchscreen
- Prowise ProWrite® Ink pen

Operating system:

- Prowise Central
- Windows 10
- Windows 7 and 8 (limited support)



PLEASE NOTE! *Prowise Central and Windows 10 support all the ProWrite Ink pen functions. Previous versions of Windows do not fully support the ProWrite® Ink pen.*

6. Getting started

6.1. Turn the touchscreen on and off

Turn on

1. Ensure the touchscreen is connected to the mains power supply.
2. Turn on the power switch on the right-hand side of the touchscreen.

There are a few different option to turn on the touchscreen once activated:

- Press the on/off button located on the right-hand side of the touchscreen
- Press the on/off button on the supplied remote control

Turn off

Using the on/off button of the control panel

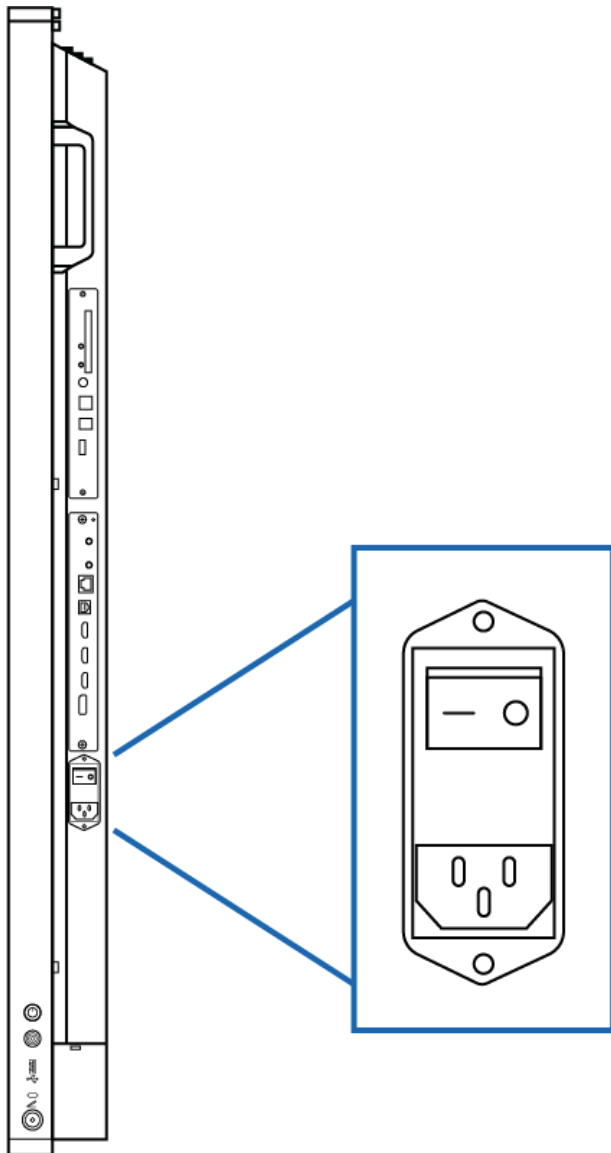

1. Press the on/off button of the control panel.
2. The notification 'The system will shut down in 15 seconds' will appear.
3. Select 'Shut down' if you wish to turn off the touchscreen or wait 15 seconds, to abort your touchscreen from closing down select the 'Cancel' button.
4. Turn off the main power supply by using the power switch on the right hand side of the touchscreen (see picture).

Using Prowise Central

1. Launch the Prowise Central Menu by placing five fingers of one hand on the screen.
2. Open the sidebar.
3. Select the 'power' icon.
4. The notification 'The system will shut down in 15 seconds' will appear.
5. Select 'Shutdown' to shut the touchscreen down immediately, or wait 15 seconds for the touchscreen to shut down automatically. To abort the shutdown of your touchscreen select the 'Cancel' button.
6. Turn off the main power supply by using the power switch on the right hand side of the touchscreen.



CAUTION! *Wait to turn off the power switch (step 6) until the LED indicator light, next to the Pro Line+ logo, has turned red. Turning off the power switch when the system is still active can cause damage to the PC module.*

Shut down automatically

When no active input source has been detected in a specific input channel, a notification will appear after 30 seconds to shut down the touchscreen. This notification will be automatically accepted after 15 seconds by the system and the touchscreen will be shut down.



PLEASE NOTE! *Turn the touchscreen off completely when moving the screen by turning off the power switch and removing the power cable from the screen.*

6.2. Starting your device for the first time

The first time you start your touchscreen, a setup guide opens to help you configure the most important settings. Follow the steps below to complete the setup:

1. Ensure the touchscreen is connected to the mains power supply.
2. Turn on the main power switch.
3. Press the power button (control panel or remote control)
4. The touchscreen will turn on and the setup guide will appear.

5. Follow the steps of the setup guide to complete the setup.
6. Once you are connected to the internet the touchscreen will automatically check for updates.
7. The welcome screen will appear and the Prowise Central environment will open right after that.
8. Open the Prowise Central menu to get started with your touchscreen. Open the menu by placing 5 fingers of one hand on the screen for at least 2 seconds.

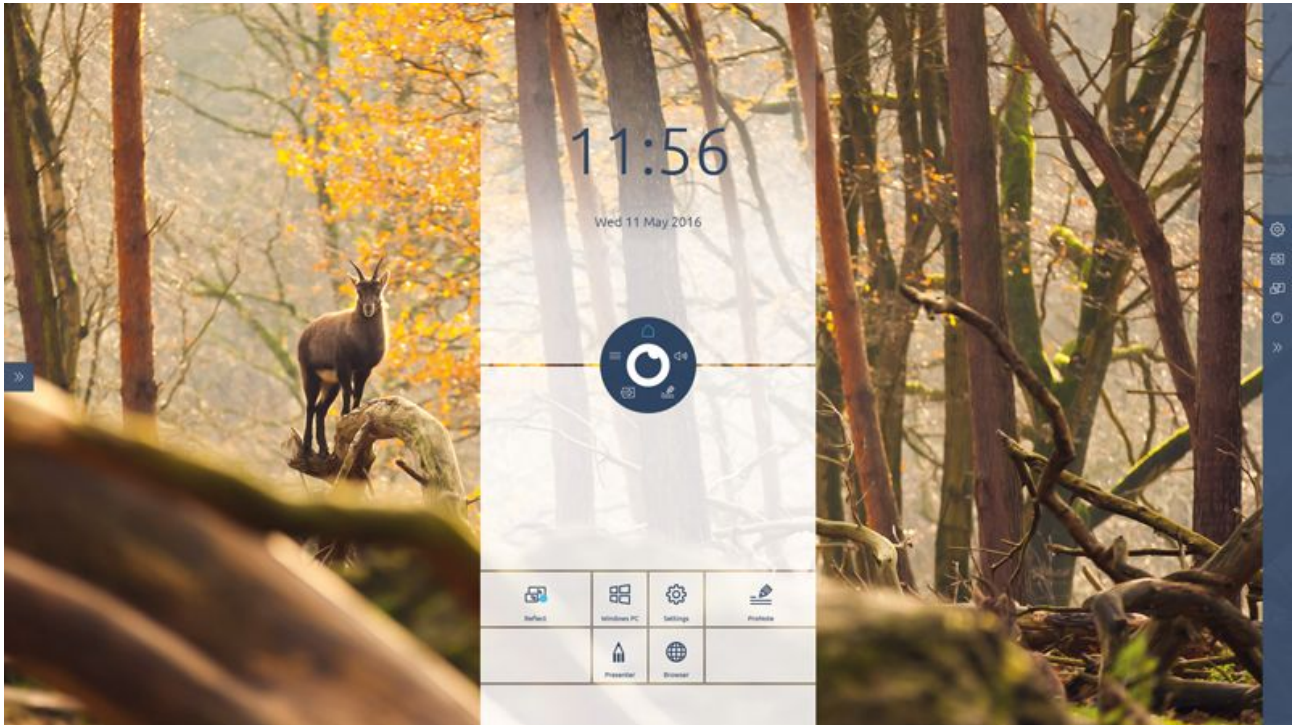

6.3. Connect to a network

Connect your touchscreen to a wireless WiFi network or via a network cable.

Ethernet

Connect the network cable to the LAN port (2) of your touchscreen. The touchscreen will automatically detect the network and connect to it as soon as 'Ethernet' has been activated in the settings menu.

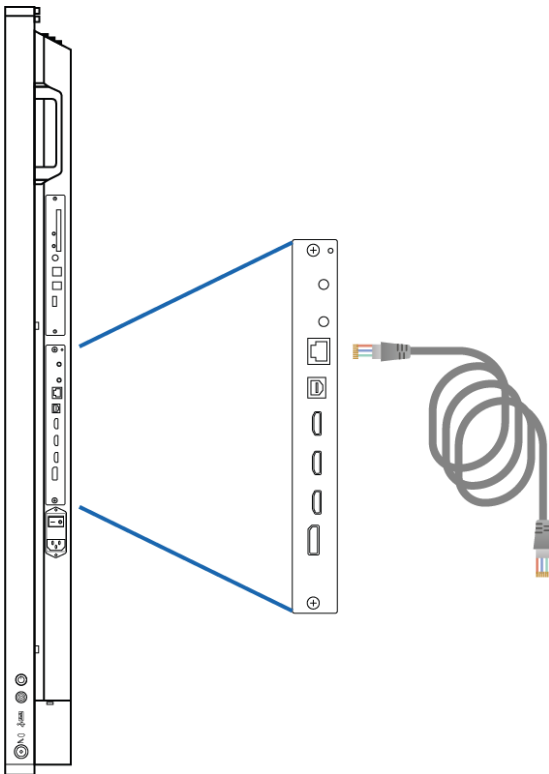

Follow the steps below to view the specifications of the network:

1. Place five fingers on the screen for at least 2 seconds to launch the Prowise Central menu.
2. Open the sidebar to access the settings menu.
3. Select the submenu 'Connectivity'.
4. Select 'Ethernet' by activating the toggle.
5. The network specifications will be displayed.

WiFi connection

Follow the steps below to set up a connection to a WiFi network:

1. Place five fingers on the screen for at least 2 seconds to launch the Prowise Central menu.
2. Open the sidebar to access the settings menu.
3. Select the submenu 'Connectivity'.
4. Select 'WiFi'. The touchscreen will scan for available networks.
5. Select the preferred network.
6. Enter the password of the network. Select the eye icon if you wish to display the characters of the password.
7. Press the 'Connect' button to connect to the wireless network.

6.4. Adjust volume

The volume of the touchscreen can be adjusted in different ways:

- With the remote control:
 - Use the volume buttons to adjust the volume.
- With the Central Menu:
 1. Place five fingers of one hand on the screen for at least 2 seconds to launch the Prowise Central menu.
 2. Select the 'audio' icon.
 3. Adjust the volume by selecting the the '+' or '-' button or move by moving the slider to increase or reduce the volume.



7. Prowise Central



PLEASE NOTE! *Some Features described in this manual are not yet implemented in Prowise Central. In the future, extra functionalities will be added to Central. The updates for Central will be installed on the touchscreen via OTA. More information about OTA can be found in "OTA (Over The Air) updates".*

7.1.Prowise Central home

Prowise Central is the new, clever and intuitive operating system of Prowise integrated in the ProLine+ Multi-touchscreen. Central brings everything together in one place.

Navigate quickly and easily to all main features and applications of your touchscreen.

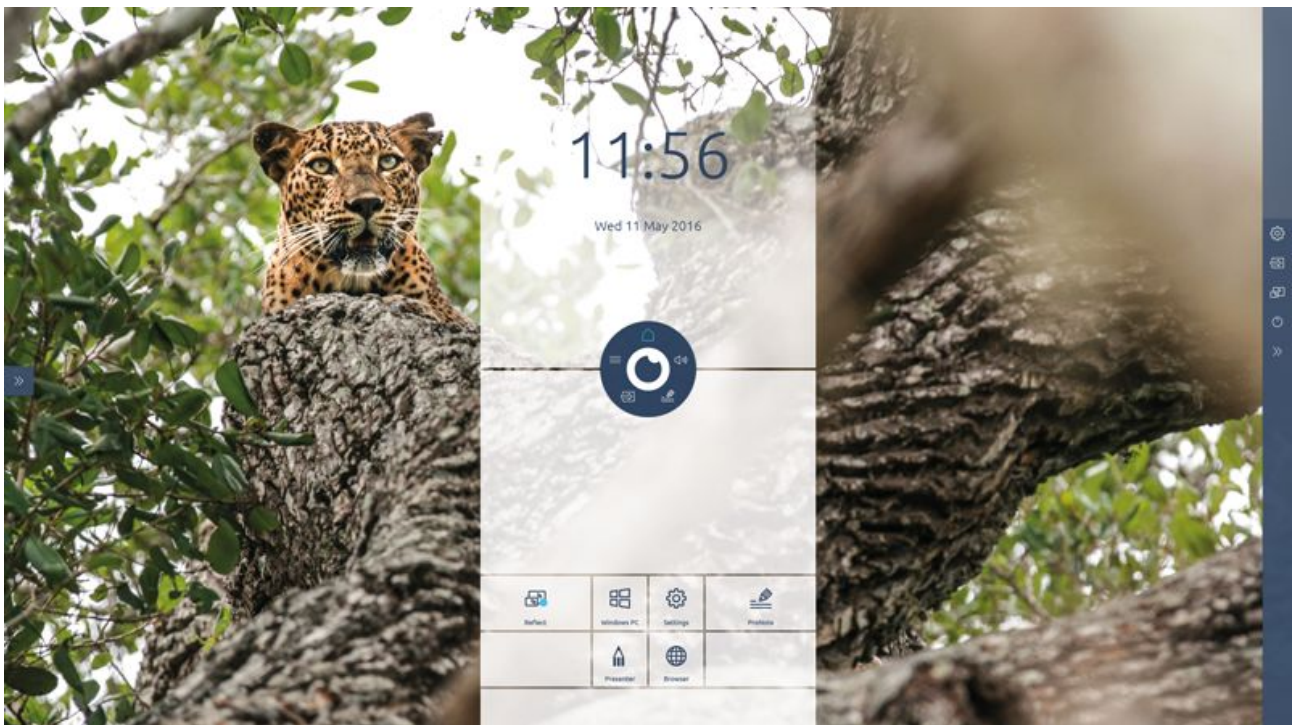

7.2.The Prowise Central menu



Easily adjust the settings of the touchscreen and open ProNote and other applications in the Prowise Central menu.

Change the position of the Prowise Central menu by dragging the circle over the screen and dropping it at your preferred position. The position of the sidebar can also be changed by selecting the arrows at the side of the screen. The sidebar will be displayed when opening the Prowise Central menu.

Launch Prowise Central menu

You can launch the Prowise Central menu in different ways:

- Place five fingers of one hand on the screen for at least 2 seconds.
- Press the Prowise Central menu button on the remote control.

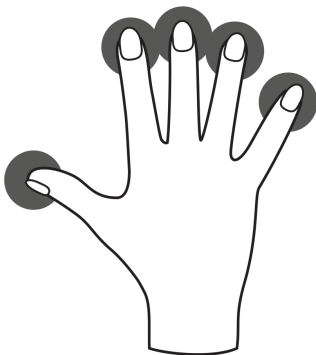

Close down the Prowise Central menu

Click on the middle of the eye (inside circle of the Central menu) to close down the Prowise Central menu or press the “back” button on the remote control. The sidebar will close down as well.

8. Adjust settings

The settings menu of Central is located in the sidebar. Here you can adjust multiple settings of your ProLine+ Multi-touchscreen, such as: display and audio settings, connectivity, NFC and other settings.

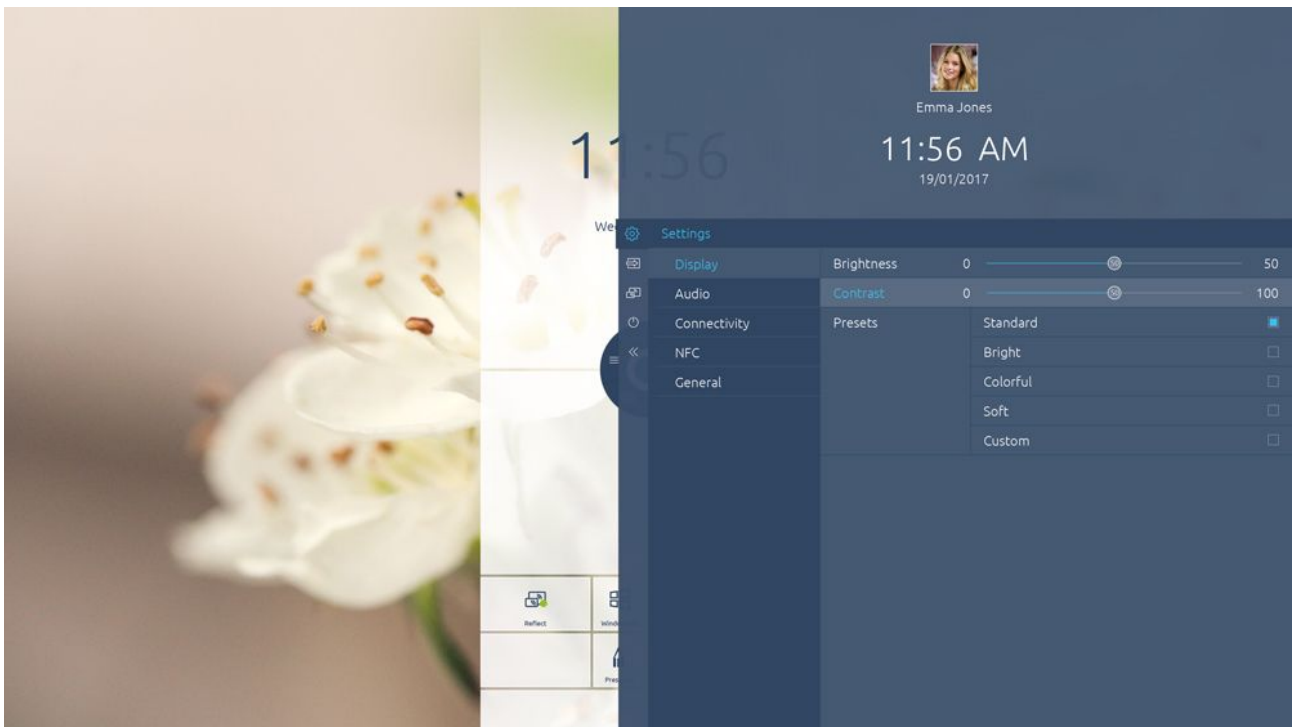

8.1. Display

Adjust a number of aspects in the tab 'display', such as:

- Brightness
- Contrast

Choose from pre-installed colour settings or adjust the colour temperature. Depending on the chosen input source (PC, laptop, etc.), it is also possible to adjust the aspect ratio.

8.2. Audio

To adjust the volume settings, select the “Audio” tab in the “Settings” menu. In this tab, use the sliders to adjust the advanced sound settings.

There are a number of pre-installed sound settings to choose from and it is also possible to mute the sound in this menu.



PLEASE NOTE! *The audio outputs (the analogue line output and the digital Coax port) are always active. If you connect an external audio device to the touchscreen and only wish to use this audio device, press the “Mute” button on the remote control or in the Central menu to turn off the touchscreen’s internal sound.*

8.3.Connectivity

Wifi

When WiFi is selected, the touchscreen searches for available WiFi networks. Connect to a WiFi network as follows:

1. Click “WiFi” in the “Settings” menu.
2. Activate the WiFi toggle
3. Select the desired network.
4. Enter the password for the network (click the eye to display the entered password).
5. Click “Connect”.

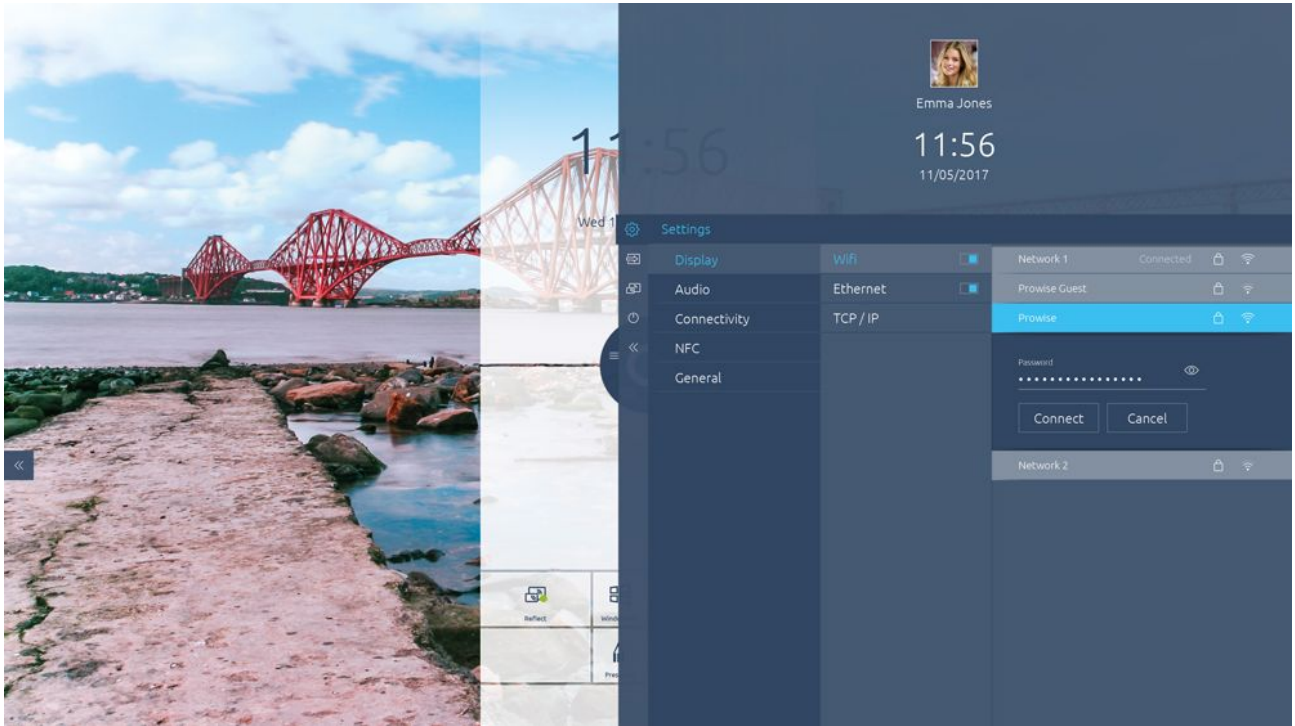

Ethernet

It is also possible to connect to the Internet using a network cable. To do so, connect the network cable to the touchscreen's LAN port (2) and activate "Ethernet" in the settings menu. The "Ethernet" submenu contains more information about the network specifications.

TCP/IP

This submenu contains the network specifications of the network the touchscreen is connected to.



PLEASE NOTE! *When Ethernet is activated, the WiFi connection is disconnected.*

8.4. General settings

It is possible to activate and edit certain advanced functions in the general settings.

Updates

Automatic updates – OTA updates – are activated by default. The touchscreen will automatically search and install the newest updates. If a new update is available, it is installed when the touchscreen gets turned off.

Check for updates – It is possible to manually update the touchscreen. If automatic updates are deactivated, it is important to regularly search manually for available updates in order to ensure that the touchscreen functions optimally.



PLEASE NOTE! *A WiFi/Internet connection with Prowise Central is required for automatic updates.*



PLEASE NOTE! *Make sure the date and time in Prowise Central are set correctly to make sure OTA will function properly.*

About this touchscreen

This submenu contains more information about the ProLine+ Multi-touchscreen. The touchscreen's name can also be changed here. This function can be useful when trying to find the touchscreen on a different device, such as when using Reflect.

Language

You can change the language settings of the menu into the following languages: English, Danish, Dutch, French, German, Italian, Swedish, Norwegian and Spanish.

The language change only applies to the Prowise Central menu.

Date and time

The date and time can be edited in this submenu. For example, it is possible to choose between a 12-hour and a 24-hour time display. When you choose to automatically adjust the date and time, the touchscreen displays the correct time for your region based on the network it is connected to. Furthermore, the way the date is displayed can be changed between mm/dd/yyyy and dd/mm/yyyy.

RS232

Serial communications, RS232, can be turned off for security reasons if you wish to do so. The codes can be found in the appendix of the User manual.

Menu gesture

There are various ways of displaying the menu. The standard method for displaying the menu is to touch the touchscreen with five fingers of one hand for two seconds. In the submenu menu gesture, it is possible to deactivate the function to open the menu by touching the touchscreen. If the menu gesture function is deactivated, it is not possible to display the menu by touching the touchscreen with five fingers. The menu can then only be displayed using the remote control.

Key lock

The buttons of the control panel can be locked. Activating this function renders the control panel's buttons inactive.



IR lock

The remote control's infrared signal can be locked. The IR signal is locked using a lock on the remote control. It is not possible to lock the buttons and the IR signal at the same time.



8.5. Input

It is possible to change the touchscreen's input source. This is particularly useful when using the PC module (OPS) or an external input source, such as an external PC or laptop.

The touchscreen offers the choice between the following inputs:

- Prowise Central home
- PC (the PC module)
- HDMI 1 input (HDMI 2.0 (4K @ 60 Hz))
- HDMI 2 input (HDMI 2.0 (4K @ 60 Hz))
- HDMI 3 input (HDMI ARC 2.0 (4K @ 60 Hz))
- DP input (Displayport 1.2 (4K @ 60 Hz))

The touchscreen displays a message if there is no active signal coming from the chosen input source. In that case, select a different input or connect a device to the chosen input so the touchscreen receives a signal. After 30 seconds, the touchscreen displays the message "The system will shut down in: 15 seconds." Select "Shut down" or wait 15 seconds to turn off the touchscreen. Select "Cancel" to stop the touchscreen from turning off, this allows you to navigate to a different input source.

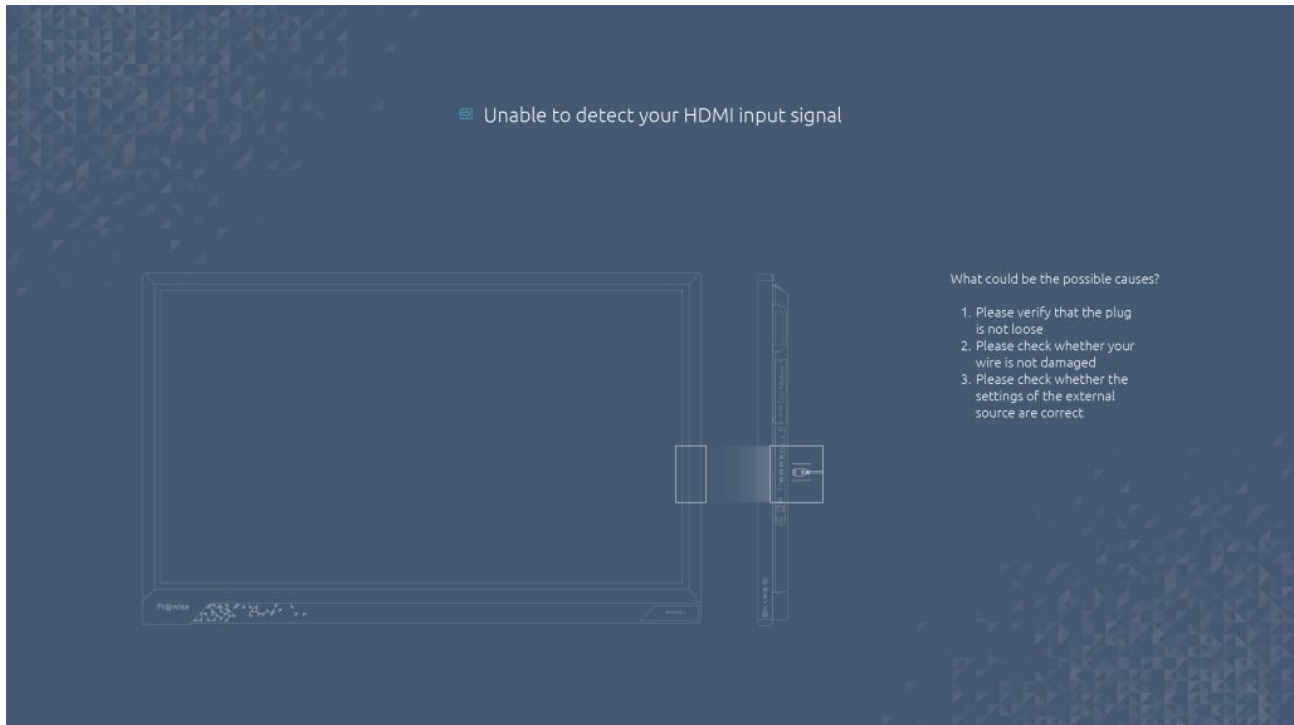

8.6. On/Off

The On/Off button in the menu can be used to turn off the touchscreen. All activated programs will be closed when the touchscreen gets turned off. It is, therefore, important to save all your files before turning off the touchscreen.



PLEASE NOTE! *Save your files before turning off the touchscreen and regularly make backups of your files. Data may be lost if this is not done.*

9.OTA (Over The Air) updates

OTA updates – over-the-air updates – ensure that you always have the latest software version installed on the touchscreen. The only thing required for OTA updates is a connection to the Internet with Prowise Central, which can be either a Wi-Fi connection or an ethernet connection.

Automatic (OTA) updates are activated by default. The updates are installed the when the touchscreen gets turned off. This function can be turned off in the “General Settings” menu. However, Prowise recommends always having OTA updates activated.









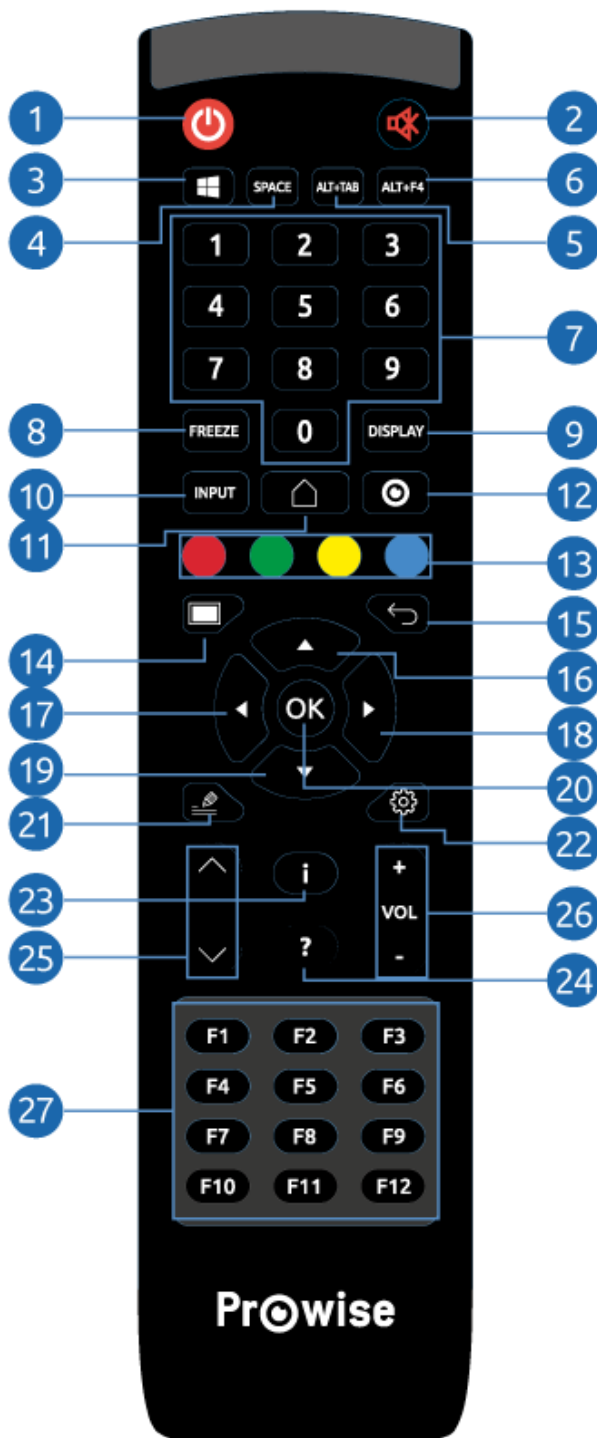

PLEASE NOTE! *OTA updates require a WiFi or an ethernet (wired network) connection to Prowise Central.*

10. Remote control

10.1. Schematic view and explanation of the buttons



1	Power	Press this button to turn the touchscreen on or off. To turn the touchscreen off, press this button and then press Enter to confirm.
2	Mute	Enable or disable the internal speakers of the touchscreen.
3	Windows	Open the start-menu in Windows (Only when the PC module is activated).
4	Space	Space button (PC module).
5	Alt-Tab	Navigate between programs (PC module).
6	Alt-F4	Closes the current program (PC module).
7	Numeric keys (0-9)	numeric selection buttons.
8	Freeze	Pauses or resumes the current frame on the screen. The freeze function can also be disabled by touching the screen.
9	Display	This button has been reserved for future updates.
10	Input	Opens the Prowise Central input settings.
11		If an input other than Prowise Central home is active, this button can be used to return to Prowise Central home.
12		Opens the Prowise Central menu.
13	Coloured buttons (red, green, yellow and blue)	These buttons are reserved for future updates.
14		Temporarily disables the screen. This is depicted in the form of a black screen.
15		Close the Prowise Central menu.
16	↑	Navigation button – up (PC module).
17	←	Navigation button – left (PC module).
18	→	Navigation button – right (PC module).
19	↓	Navigation button – down (PC module).
20	Enter	Confirm selection.

21		These buttons are reserved for future updates.
22		Opens the Prowise Central settings menu.
23	i	These buttons are reserved for future updates.
24	?	These buttons are reserved for future updates.
25	 	These buttons are reserved for future updates.
26	VOL+ ; VOL-	Adjust the volume
27	F1 - F12	Function keys (PC module).

10.2. Angle at which remote control is used

To use the remote control, point it to the IR receiver of the touchscreen. The remote control has a range of around 8 metres.

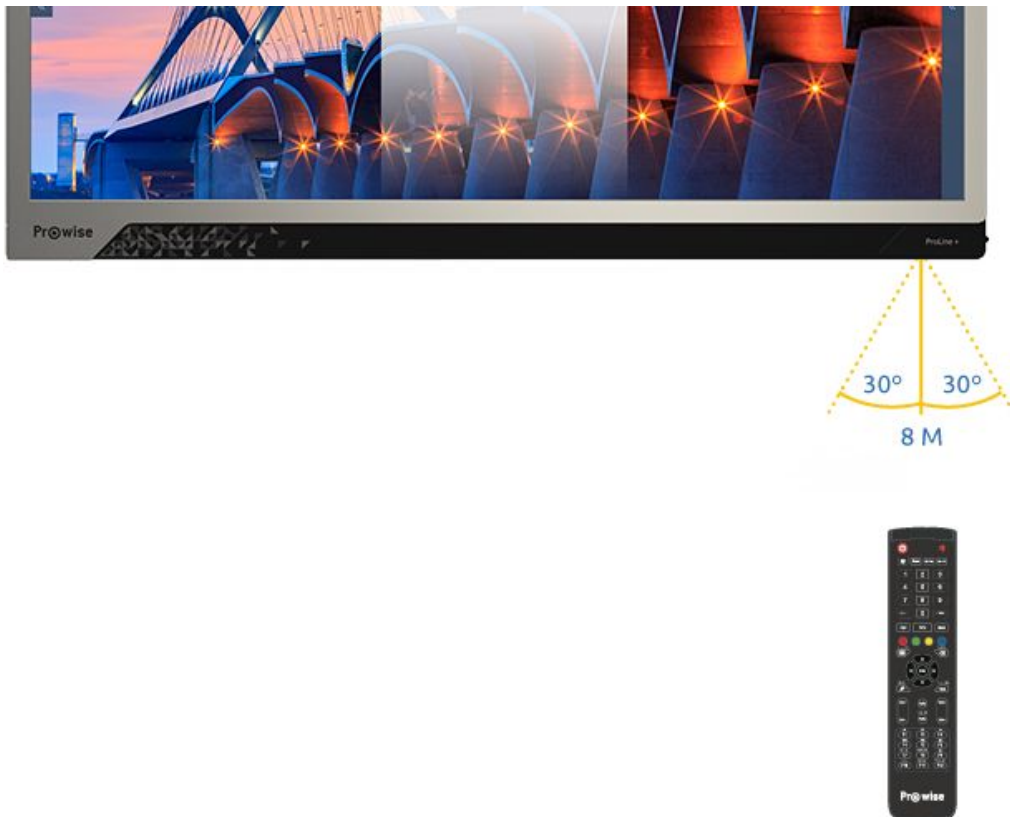



CAUTION! *If any obstacles are situated between the remote control and the receiver of the touchscreen, the remote control may not work properly.*

10.3. Inserting the batteries

Before using the remote control for the first time, you must insert the two (1.5V AAA) batteries, supplied with the remote control. Once the batteries are running out and the remote control is no longer working properly, you must change the batteries. You can do this as follows:

1. Carefully remove the cover plate on the reverse side of the remote control.
2. Insert the two batteries (1.5V, AAA) into the remote control.
3. Place them with the positive and negative poles as indicated by the (+) and (-) signs in the battery compartment.
4. Close the battery compartment again by carefully replacing the cover plate.



WARNING! *Remove any leaking batteries as quickly as possible from the remote control. Thoroughly wash your hands afterwards. The leaking chemicals are toxic and must never come into contact with the mouth, skin or eyes.*



PLEASE NOTE! Only use 1.5 V AAA batteries. Insert them as shown by the instructions on the remote control.

11. Connect peripherals

11.1. Connect the ProLine+ Multi-touchscreen to an external PC

11.1.1. Connect using a HDMI cable

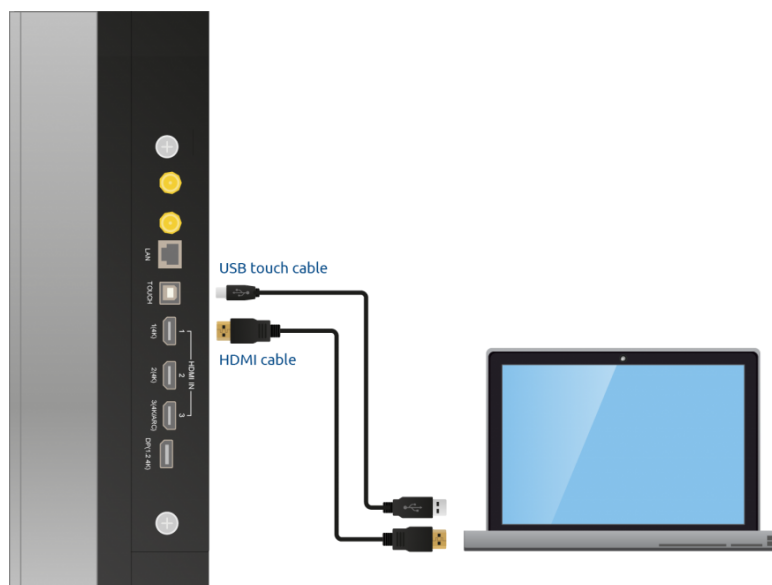

In addition to an HDMI connection, a USB touch connection is also available on the right-hand side of the touchscreen. This can be used to connect an external PC with touch functionality.

1. Connect an HDMI cable to the HDMI port of the external PC and to the HDMI input port of the touchscreen.
2. Connect the USB touch cable to the touch USB port of the touchscreen and to a USB port on the external PC.
3. Once all cables have been connected, switch on the touchscreen and the external PC.

- Once the touchscreen and the external PC have booted up, navigate in the Central menu to 'Input' and select the correct HDMI source.



PLEASE NOTE! *We recommend using a cable that is as short as possible and is no longer than 3 metres.*

11.1.2. Connect using a DP cable

In addition to a DP connection (6), a USB touch connection is also available on the right-hand side of the touchscreen. This can be used to connect an external PC with touch functionality.

- Connect a DP cable to the DP port of the external PC and to the DP input port (6) of the touchscreen.
- Connect the USB touch cable to the touch USB port of the touchscreen and to a USB port on the external PC.
- Once all cables have been connected, switch on the touchscreen and the external PC.
- Once the touchscreen and the external PC have booted up, navigate in the Central menu to 'Input' and select the DP input source.

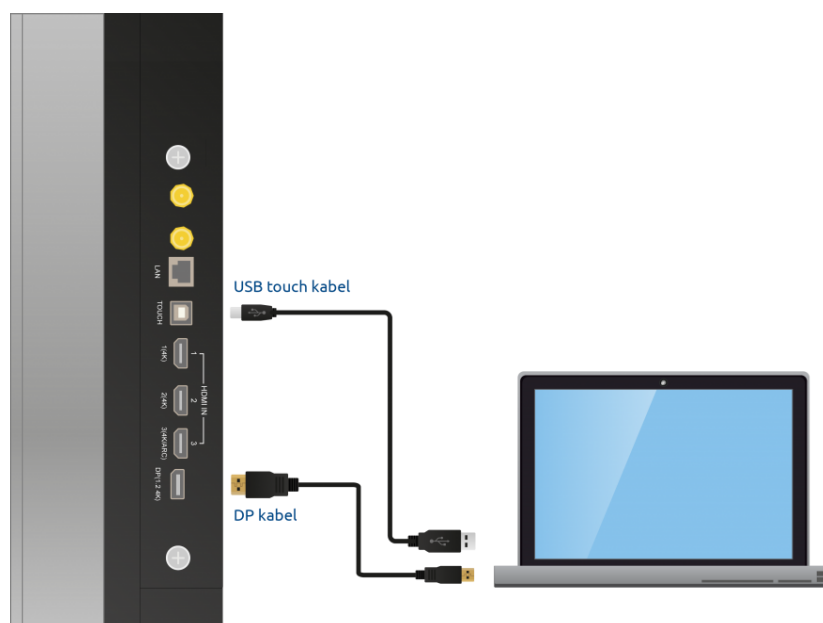

11.2. Connecting the ProLine+ Multi-touchscreen to audio equipment

11.2.1. Connecting headphones:

Connect headphones by plugging them into the analogue output headphones (10). Use the touchscreen's volume control to adjust the headphones volume.

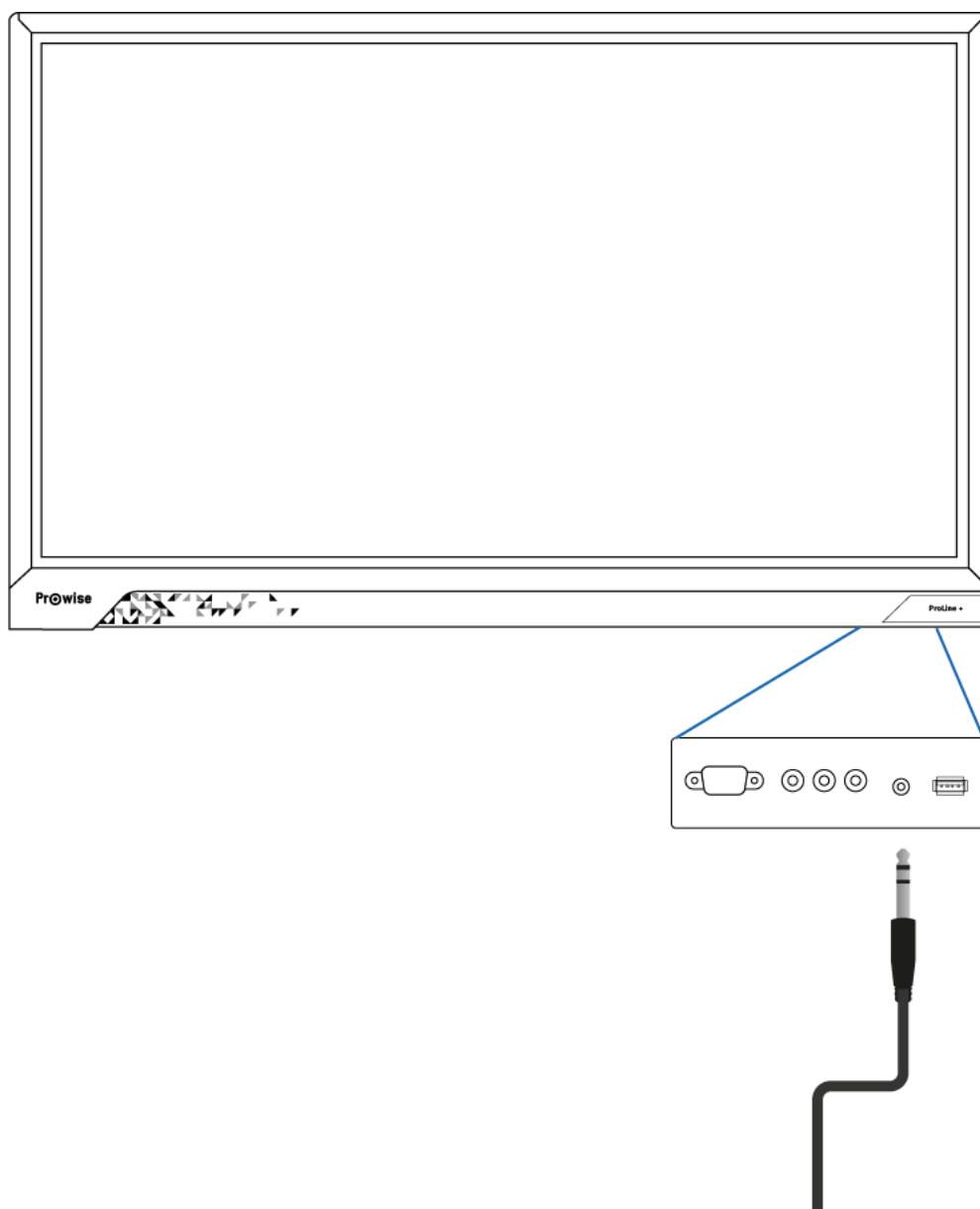

11.2.2. Connecting an amplifier

Connect an amplifier by plugging it into the analogue audio output (11) or the digital Coax port (12). Use the amplifier's volume control to adjust the amplifier's volume.

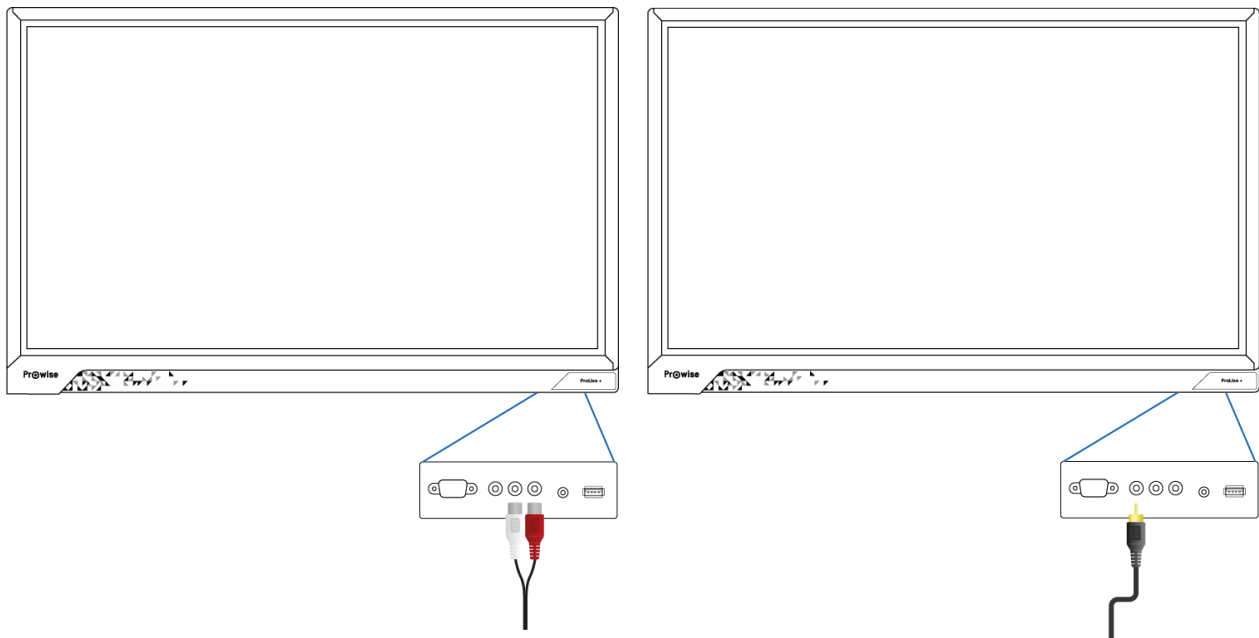

PLEASE NOTE! *The audio outputs (the analogue line output and the digital Coax port) are always active. If you connect an external audio device to the touchscreen and only wish to use this audio device, press the "Mute" button on the remote control or in the Central menu to turn off the touchscreen's internal speakers.*

11.2.3. Connecting using the HDMI port (ARC):

It is possible to connect an external audio device using an ARC (Audio Return Channel) connection. This allows the external audio device to be controlled via the touchscreen. To connect an audio device via ARC, insert one end of an HDMI cable into the touchscreen's HDMI port with ARC support (5) and the other end in the external audio device's HDMI port.

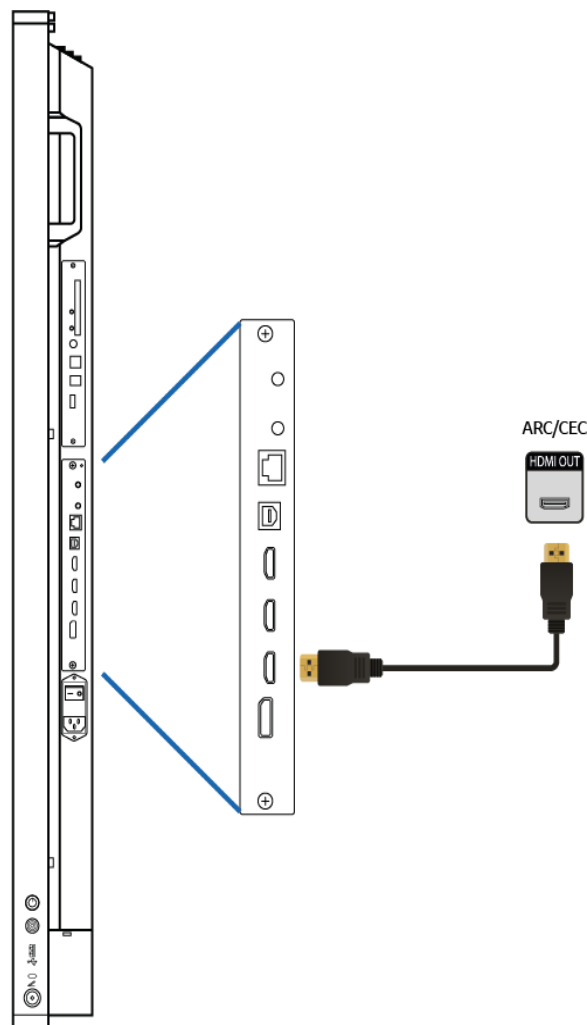

11.2.4. Connecting using the HDMI port (CEC)

CEC (Consumer Electronics Control) is a functionality that works via HDMI. The devices that are connected to each other in this way communicate via CEC. This allows these devices to be controlled via the touchscreen's remote control.

Connect a device via CEC by inserting an HDMI cable in the touchscreen's HDMI port (5).

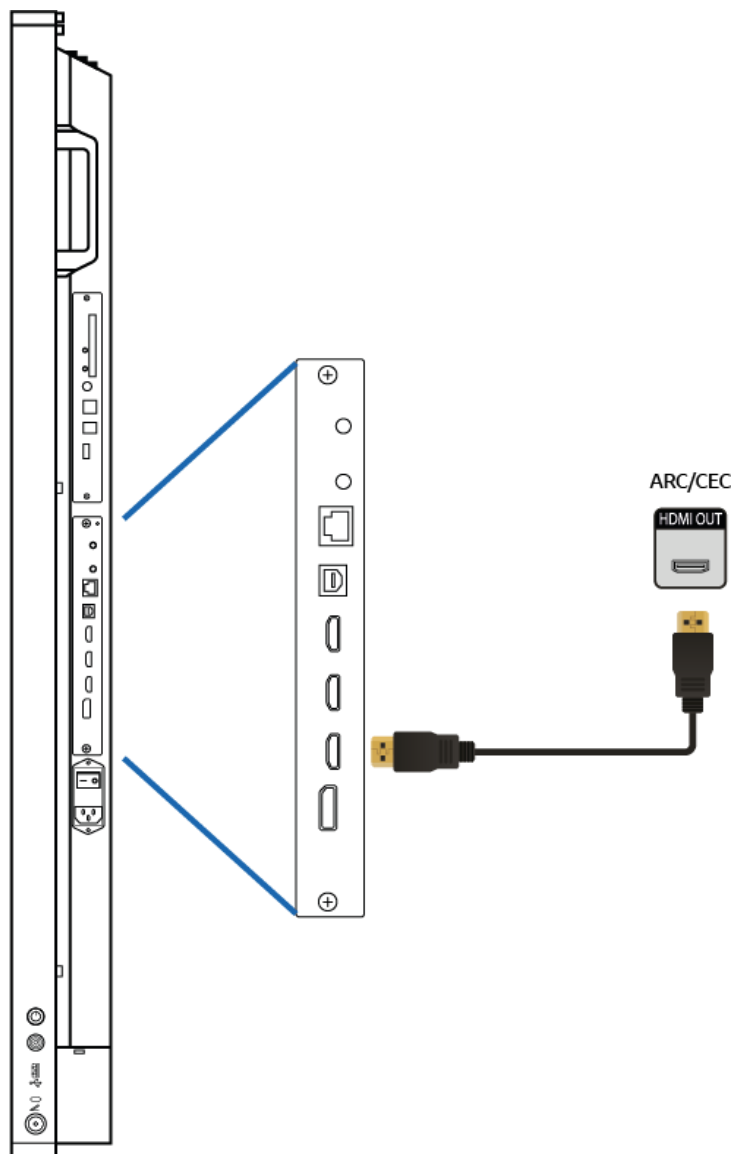

Appendix

RS232 Protocol and Code list

This appendix describes the hardware interface specification and software protocols of RS232 interface communication between the touchscreen and the connected PC or other control unit with RS232 protocol.

**Male DSUB 9Pin
(outside view)**



Pin #	Signal	Remark
1	NC	
2	TXD	Output to TV
3	RXD	Input from TV
4	NC	
5	GND	
6	NC	
7	NC	
8	NC	
9	NC	
frame	GND	

Pin2 is TXD Pin3 is RXD. Pin to Pin connection as below.

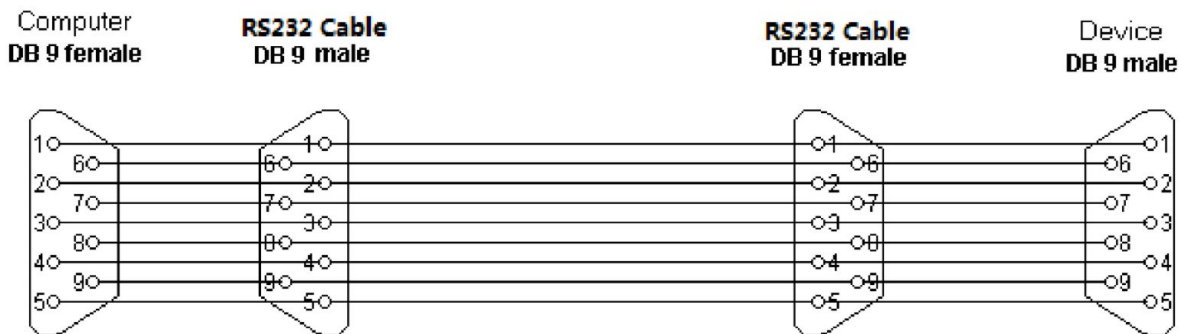

Serial Port Settings

Items	Value
Baud Rate	9600bps (fixed)
Data Bits	8 (fixed)
Stop Bits	1 (fixed)
Parity	None (fixed)
Stream Control	None (fixed)

Protocol Description

Command format

Version	0.9
Command Head	AA BB CC
Command Body	3 bytes + 1 byte checksum(of leading 3 bytes)
Command Tail	DD EE FF

RS232 Code list

Category	Function	Code	Remark
Power	Power on	AA BB CC 01 00 00 01 DD EE FF	
	Power off	AA BB CC 01 01 00 02 DD EE FF	
Source	HDMI 1	AA BB CC 02 06 00 08 DD EE FF	
	HDMI 2	AA BB CC 02 07 00 09 DD EE FF	
	HDMI 3	AA BB CC 02 05 00 07 DD EE FF	
	DP	AA BB CC 02 09 00 0B DD EE FF	
	PC	AA BB CC 02 08 00 0A DD EE FF	
	Prowise Central(Android)	AA BB CC 02 0A 00 0C DD EE FF	
Audio	Volume	AA BB CC 03 00 xx ** DD EE FF	Range : 0 ~ 100
	Mute	AA BB CC 03 01 00 04 DD EE FF	
	Unmute	AA BB CC 03 01 01 05 DD EE FF	
	Bass	AA BB CC 03 07 xx ** DD EE FF	Range : 0 ~ 100
	Treble	AA BB CC 03 08 xx ** DD EE FF	Range : 0 ~ 100
	Balance	AA BB CC 03 04 yy ## DD EE FF	Range : -50 ~ 50
	Audio preset : Standard	AA BB CC 03 06 00 09 DD EE FF	
	Audio preset : Movie	AA BB CC 03 06 01 0A DD EE FF	
	Audio preset : Meeting	AA BB CC 03 06 02 0B DD EE FF	
	Audio preset : Class	AA BB CC 03 06 03 0C DD EE FF	
Audio preset : Custom	AA BB CC 03 06 04 0D DD EE FF		
Screen / Display	Aspect Ratio : Auto	AA BB CC 08 04 00 0C DD EE FF	
	Aspect Ratio : 4:3	AA BB CC 08 01 00 09 DD EE FF	
	Aspect Ratio : 16:9	AA BB CC 08 00 00 08 DD EE FF	
	Aspect Ratio : PTP	AA BB CC 08 07 00 0F DD EE FF	
	Brightness	AA BB CC 08 09 xx ** DD EE FF	Range : 0 ~ 100, Backlight control
	Contrast	AA BB CC 08 0A xx ** DD EE FF	Range : 0 ~ 100
	Color(Saturation)	AA BB CC 08 0B xx ** DD EE FF	Range : 0 ~ 100
	Sharpness	AA BB CC 08 0C xx ** DD EE FF	Range : 0 ~ 100, N/A in PTP mode
	Display preset : Standard	AA BB CC 08 0D 00 15 DD EE FF	
	Display preset : Bright	AA BB CC 08 0D 01 16 DD EE FF	
	Display preset : Colorful	AA BB CC 08 0D 02 17 DD EE FF	
	Display preset : Soft	AA BB CC 08 0D 03 18 DD EE FF	
	Display preset : Custom	AA BB CC 08 0D 04 19 DD EE FF	
Settings	Languages : English	AA BB CC 38 02 00 3A DD EE FF	
	Languages : Dutch	AA BB CC 38 02 01 3B DD EE FF	
	Languages : German	AA BB CC 38 02 02 3C DD EE FF	
	Languages : French	AA BB CC 38 02 03 3D DD EE FF	
	Languages : Italian	AA BB CC 38 02 04 3E DD EE FF	
	Languages : Spanish	AA BB CC 38 02 05 3F DD EE FF	
	Languages : Swedish	AA BB CC 38 02 06 40 DD EE FF	
	Languages : Norwegian	AA BB CC 38 02 07 41 DD EE FF	
	Languages : Danish	AA BB CC 38 02 08 42 DD EE FF	
	User menu : Off	AA BB CC 38 03 00 3B DD EE FF	
	User menu : 5 Fingers	AA BB CC 38 03 01 3C DD EE FF	
	User menu : 2 Fingers	AA BB CC 38 03 02 3D DD EE FF	TBD(App)

	User menu : Both	AA BB CC 38 03 03 3E DD EE FF	TBD(App)
	Key lock : Off	AA BB CC 38 04 00 3C DD EE FF	
	Key lock : On	AA BB CC 38 04 01 3D DD EE FF	
	IR lock : Off	AA BB CC 38 05 00 3D DD EE FF	
	IR lock : On	AA BB CC 38 05 01 3E DD EE FF	
	Touch : Off	AA BB CC 38 07 00 3F DD EE FF	
	Touch : On	AA BB CC 38 07 01 40 DD EE FF	
	RS232 : Off	AA BB CC 38 08 00 40 DD EE FF	
	RS232 : On	N/A	
PC	PC Power ON	AA BB CC 09 01 00 0A DD EE FF	
	PC Power OFF	AA BB CC 09 00 00 09 DD EE FF	
Remote Control	WIN	AA BB CC 07 0B 00 12 DD EE FF	
	Space	AA BB CC 07 46 00 4D DD EE FF	
	Alt+Tab	AA BB CC 07 1D 00 24 DD EE FF	
	Alt+F4	AA BB CC 07 1F 00 26 DD EE FF	
	NUM_1	AA BB CC 07 00 00 07 DD EE FF	
	NUM_2	AA BB CC 07 10 00 17 DD EE FF	
	NUM_3	AA BB CC 07 11 00 18 DD EE FF	
	NUM_4	AA BB CC 07 13 00 1A DD EE FF	
	NUM_5	AA BB CC 07 14 00 1B DD EE FF	
	NUM_6	AA BB CC 07 15 00 1C DD EE FF	
	NUM_7	AA BB CC 07 17 00 1E DD EE FF	
	NUM_8	AA BB CC 07 18 00 1F DD EE FF	
	NUM_9	AA BB CC 07 19 00 20 DD EE FF	
	NUM_0	AA BB CC 07 1B 00 22 DD EE FF	
	Freeze/Unfreeze	AA BB CC 07 1C 00 23 DD EE FF	
	Display	AA BB CC 07 4C 00 53 DD EE FF	
	Input	AA BB CC 07 07 00 0E DD EE FF	
	Home	AA BB CC 07 48 00 4F DD EE FF	
	Menu	AA BB CC 07 0D 00 14 DD EE FF	
	Backspace	AA BB CC 07 40 00 47 DD EE FF	
	Blank screen	AA BB CC 07 4E 00 55 DD EE FF	
	Up	AA BB CC 07 47 00 4E DD EE FF	
	Down	AA BB CC 07 4D 00 54 DD EE FF	
	Left	AA BB CC 07 49 00 50 DD EE FF	
	Right	AA BB CC 07 4B 00 52 DD EE FF	
	Enter	AA BB CC 07 4A 00 51 DD EE FF	
	Back / Escape	AA BB CC 07 0A 00 11 DD EE FF	
	VOL+	AA BB CC 07 03 00 0A DD EE FF	
	VOL-	AA BB CC 07 41 00 48 DD EE FF	
	PageUp	AA BB CC 07 42 00 49 DD EE FF	
	PageDown	AA BB CC 07 0F 00 16 DD EE FF	
	F1	AA BB CC 07 45 00 4C DD EE FF	
	F2	AA BB CC 07 12 00 19 DD EE FF	
	F3	AA BB CC 07 51 00 58 DD EE FF	
	F4	AA BB CC 07 5B 00 62 DD EE FF	
	F5	AA BB CC 07 44 00 4B DD EE FF	
	F6	AA BB CC 07 50 00 57 DD EE FF	
	F7	AA BB CC 07 43 00 4A DD EE FF	
	F8	AA BB CC 07 1A 00 21 DD EE FF	
	F9	AA BB CC 07 04 00 0B DD EE FF	
	F10	AA BB CC 07 59 00 60 DD EE FF	
	F11	AA BB CC 07 57 00 5E DD EE FF	
	F12	AA BB CC 07 08 00 0F DD EE FF	
Shift + F10	AA BB CC 07 16 00 1D DD EE FF		
Red	AA BB CC 07 5C 00 63 DD EE FF		
Green	AA BB CC 07 5D 00 64 DD EE FF		
Yellow	AA BB CC 07 5E 00 65 DD EE FF		
Blue	AA BB CC 07 5F 00 66 DD EE FF		

Polling Code List

Mode	Function	External Host Command	System Response	Response
Power Status	Obtain Power	AA BB CC 01 02 00 03 DD EE FF	AA BB CC 80 00 00 80 DD EE FF	On

			AA BB CC 80 01 00 81 DD EE FF	Stand-by
Source	Obtain Input	AA BB CC 02 00 00 02 DD EE FF	AA BB CC 81 06 00 87 DD EE FF	HDMI 1
			AA BB CC 81 07 00 88 DD EE FF	HDMI 2
			AA BB CC 81 05 00 86 DD EE FF	HDMI 3
			AA BB CC 81 09 00 8A DD EE FF	DP
			AA BB CC 81 08 00 89 DD EE FF	PC
			AA BB CC 81 0A 00 8B DD EE FF	Prowise Central(Android)
Audio	Obtain Volume	AA BB CC 03 02 00 05 DD EE FF	AA BB CC 82 00 xx ** DD EE FF	Volume Level
	Obtain Mute	AA BB CC 03 03 00 06 DD EE FF	AA BB CC 82 01 00 83 DD EE FF	Muted
			AA BB CC 82 01 01 84 DD EE FF	Unmuted
	Obtain Bass	AA BB CC 39 08 00 41 DD EE FF	AA BB CC 40 08 xx ** DD EE FF	Bass Level
	Obtain Treble	AA BB CC 39 09 00 42 DD EE FF	AA BB CC 40 09 xx ** DD EE FF	Treble Level
	Obtain Balance	AA BB CC 39 0A 00 43 DD EE FF	AA BB CC 40 0A yy ## DD EE FF	Balance Level
	Obtain Sound	AA BB CC 39 0B 00 44 DD EE FF	AA BB CC 40 0B 00 4B DD EE FF	Standard
			AA BB CC 40 0B 01 4C DD EE FF	Movie
			AA BB CC 40 0B 02 4D DD EE FF	Meeting
			AA BB CC 40 0B 03 4E DD EE FF	Class
		AA BB CC 40 0B 04 4F DD EE FF	Custom	
Screen / Display	Obtain Aspect Ratio	AA BB CC 39 07 00 40 DD EE FF	AA BB CC 40 07 00 47 DD EE FF	Auto
			AA BB CC 40 07 01 48 DD EE FF	4:3
			AA BB CC 40 07 02 49 DD EE FF	16:9
			AA BB CC 40 07 03 4A DD EE FF	PTP
	Obtain Brightness	AA BB CC 39 02 00 3B DD EE FF	AA BB CC 40 02 xx ** DD EE FF	Brightness Level
	Obtain Contrast	AA BB CC 39 03 00 3C DD EE FF	AA BB CC 40 03 xx ** DD EE FF	Contrast Level
	Obtain Hue	AA BB CC 39 04 00 3D DD EE FF	AA BB CC 40 04 xx ** DD EE FF	Color(Saturation) Level
	Obtain Sharpness	AA BB CC 39 05 00 3E DD EE FF	AA BB CC 40 05 xx ** DD EE FF	Sharpness Level
	Obtain Display Preset	AA BB CC 39 06 00 3F DD EE FF	AA BB CC 40 06 00 46 DD EE FF	Standard
			AA BB CC 40 06 01 47 DD EE FF	Bright
			AA BB CC 40 06 02 48 DD EE FF	Colorful
			AA BB CC 40 06 03 49 DD EE FF	Soft
			AA BB CC 40 06 04 4A DD EE FF	Custom
Settings	Obtain Freeze	AA BB CC 34 02 00 36 DD EE FF	AA BB CC 34 03 01 38 DD EE FF	Freeze active
			AA BB CC 34 03 00 37 DD EE FF	Freeze not active
	Obtain Blank Screen	AA BB CC 35 02 00 37 DD EE FF	AA BB CC 35 03 01 39 DD EE FF	Blank screen active
			AA BB CC 35 03 00 38 DD EE FF	Blank screen not active
	Obtain Keylock State	AA BB CC 39 00 00 39 DD EE FF	AA BB CC 40 00 01 41 DD EE FF	Key-lock active
			AA BB CC 40 00 00 40 DD EE FF	Key-lock not active
	Obtain IR Lock State	AA BB CC 39 01 00 3A DD EE FF	AA BB CC 40 01 01 42 DD EE FF	IR-lock active
			AA BB CC 40 01 00 41 DD EE FF	IR-lock not active
	Obtain Sleep Timer	AA BB CC 39 0D 00 46 DD EE FF	AA BB CC 40 0D zz && DD EE FF	Sleep timer Level
	Obtain Language	AA BB CC 39 0F 00 48 DD EE FF	AA BB CC 40 0F 00 4F DD EE FF	English
			AA BB CC 40 0F 01 50 DD EE FF	Dutch
			AA BB CC 40 0F 02 51 DD EE FF	German
			AA BB CC 40 0F 03 52 DD EE FF	French
			AA BB CC 40 0F 04 53 DD EE FF	Italian
			AA BB CC 40 0F 05 54 DD EE FF	Spanish
			AA BB CC 40 0F 06 55 DD EE FF	Swedish
			AA BB CC 40 0F 07 56 DD EE FF	Norwegian
			AA BB CC 40 0F 08 57 DD EE FF	Danish
	Obtain User Menu	AA BB CC 39 10 00 49 DD EE FF	AA BB CC 40 10 00 50 DD EE FF	Off
			AA BB CC 40 10 01 51 DD EE FF	5 fingers
			AA BB CC 40 10 02 52 DD EE FF	2 fingers
			AA BB CC 40 10 03 53 DD EE FF	Both
	Obtain Touch	AA BB CC 39 12 00 4B DD EE FF	AA BB CC 40 12 01 53 DD EE FF	Touch active
		AA BB CC 40 12 00 52 DD EE FF	Touch not active	
Obtain RS232 State	AA BB CC 39 13 00 4C DD EE FF	AA BB CC 40 13 01 54 DD EE FF	RS232 active	
		N/A	RS232 not active	
PC	Obtain PC State	AA BB CC 09 02 00 0B DD EE FF	AA BB CC 83 01 00 84 DD EE FF	PC Off
			AA BB CC 83 00 00 83 DD EE FF	PC On
			AA BB CC 83 02 00 85 DD EE FF	PC Sleep