

# Prowise Touchscreen Ten G3 SE manual



This manual applies to Prowise Touchscreens with the following product numbers:

## Prowise Touchscreen Ten G3 SE

- 65": PW.1.17065.1003
- 75": PW.1.17075.1003
- 86": PW.1.17086.1003

# Index

<b>1. Unboxing your Prowise Touchscreen</b>	<b>3</b>
1.1. Products and accessories	3
2.2. Product overview	5
<b>2. Installing your Prowise Touchscreen</b>	<b>7</b>
2.1. Installation principles	7
2.2. Install it yourself	8
2.3. Cabling	9
2.4. Installing Wi-Fi antennas	9
2.5. OPS module	10
<b>3. Starting up the Prowise Touchscreen for the first time</b>	<b>12</b>
3.1. Turn on the touchscreen	12
3.2. Complete installation	13
3.3. Connecting to a network	14
<b>4. Your Prowise Touchscreen in everyday use</b>	<b>17</b>
4.1. The right position	17
4.2. Touchscreen operation	18
4.3. Pens	19
4.4. Prowise Central	19
4.5. Remote control	21
4.6. Sensors	25
4.7. Cleaning	25
<b>5. Connecting auxiliary equipment</b>	<b>27</b>
5.1. HDMI	27
5.2. USB-C	28
5.3. VGA	28
5.4. Connecting the Prowise touchscreen to audio devices	29
5.5. Connecting via the HDMI port (ARC)	31
5.6. Microphone and camera passthrough	31
5.7. Connecting via the HDMI port (CEC)	32
5.8. Using an SD card	32
<b>6. Important safety instructions</b>	<b>33</b>
6.1. Safety	33
6.2. Repairs	34
6.3. Environment	34
6.4. Recycling and disposal	35

# 1. Unboxing your Prowise Touchscreen

## 1.1. Products and accessories

Your Prowise Touchscreen comes with a number of accessories and props by default. We would like to go through all the items with you.



1. Prowise Touchscreen Ten G3 SE
2. **Accessory box:**
3. Remote control
4. 1.5V AAA batteries (2x)
5. Wi-Fi antenna (2x)
6. ProWrite® pen with different pen thicknesses (2x)
7. Pen tips (2 sets)
8. Safety Instructions
9. 1/4-inch UNC camera screw
10. VESA screws (4x)
11. Camera mount



**WARNING!** Keep packaging material, such as the foil bag, out of the reach from children. Improper use of packaging materials may result in a choking hazard.



**CAUTION!** Check that the supplied package is complete and contact our colleagues from Customer Service within five (5) days of delivery if anything is missing. Please include the serial number and a copy of the invoice.

## 2.2. Product overview

Your Prowise Touchscreen is equipped with many ports and sensors. We have listed all the options for you.

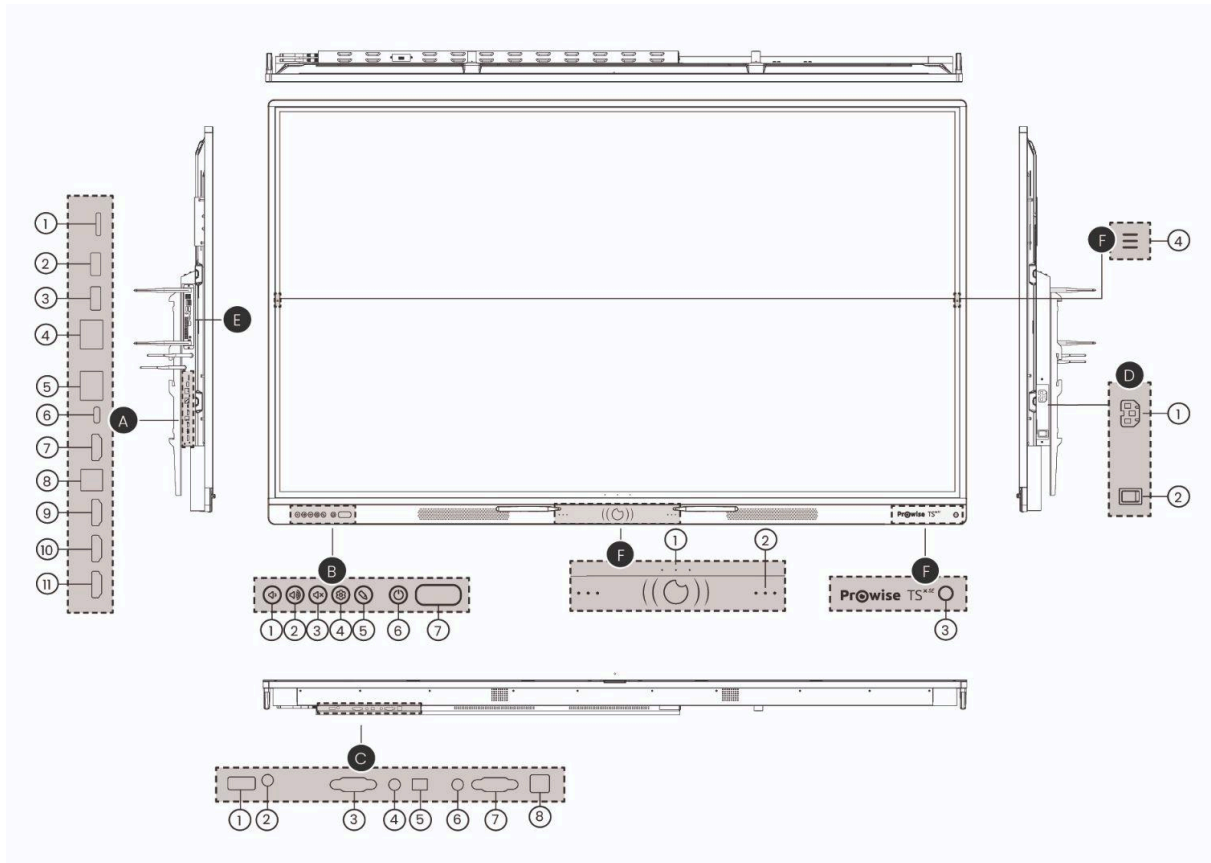

## Prowise Touchscreen Ten G3 SE

- A. Left side ports
  1. SD card reader
  2. USB 3.2 Gen1 Type A
  3. USB 3.2 Gen1 Type A
  4. LAN IN Port (RJ45)
  5. LAN OUT Port (RJ45)
  6. USB Type C (HDMI / 100W power / touch / LAN)
  7. HDMI Output 2.1
  8. USB 3.2 Gen 1 Type B (touch port for HDMI)
  9. HDMI 2.1 Type A (HDCP2.3, ARC & CEC)
  10. HDMI 2.1 Type A (HDCP2.3 CEC)
  11. HDMI 2.1 Type A (HDCP2.3 CEC)
  
- B. Bottom buttons (left)
  1. Volume -
  2. Volume +
  3. Mute
  4. Settings
  5. Annotate mode
  6. On/off button
  7. IR sensor + Light sensor
  
- C. Bottom ports
  1. USB 2.0 Type A
  2. Microphone in
  3. RS232 serial port
  4. Audio output - headphones
  5. S/PDIF optical digital audio output
  6. VGA audio inout
  7. VGA input (1920x1080p @60Hz)
  8. USB 3.0 Type-B (Touch port for VGA)
  
- D. AC input and main switch on the right
  1. AC input
  2. Main power switch
  
- E. OPS slot left side
  
- F. Front buttons and sensors
  1. Adjustable buttons
  2. Microphones
  3. IR sensor
  4. Menu buttons

## 2. Installing your Prowise Touchscreen

### 2.1. Installation principles

We recommend not installing the touchscreen yourself or having it installed by a third party. Let Prowise or a certified Prowise partner install or mount the touchscreen to avoid possible damage.

- Do not install or place the touchscreen on an unstable wall or floor, and make sure the wall or floor is strong enough to support the screen.
- Do not use the touchscreen in an industrial environment where it will frequently get exposed to vibrations, moisture and dust.
- Keep the touchscreen and all connected devices away from water and avoid dust, moisture and heat.
- Do not place the touchscreen close to equipment that generates heat.
- Make sure all the ventilation openings on the back of the touchscreen remain uncovered in order to let hot air escape, and do not build-in the touchscreen in a closed cupboard, for example.
- Only connect the touchscreen to a grounded electrical socket.

The Prowise Touchscreen can be used at an ambient temperature of 0 °C to +38 °C and a relative humidity of 10% to 90% (without condensation). When switched off, the touchscreen can be stored at a temperature from -20 °C to 60 °C and relative humidity from 10% to 90% (without condensation).



**WARNING!** Use the touchscreen for a maximum of 16 hours a day to avoid overloading the system. Non-compliance with these instructions can lead to faults or damage to the touchscreen.

## 2.2. Install it yourself

We do not recommend it, but if you want to install the touchscreen yourself or have it installed by someone else, follow the steps below:

- Do not install the touchscreen alone.
- Use a certified Prowise wall bracket to attach the Prowise Touchscreen to a wall.
- Use a Prowise VESA bracket to install the screen on a Prowise Lift system.
- Please ensure the wall is strong enough to carry the weight of the touchscreen.
- Connect the cables (which cables you require depends on the external devices you use, or other external sources such as a lift system).

If you use an OPS PC module, make sure the module is placed correctly and locked. Install the PC module as described in the chapter 'Install OPS PC module'.

- Make sure to only connect the power cable when the above elements have been connected, and only use the power cable supplied and certified by Prowise.



**CAUTION!** Prowise cannot be held responsible for any damage or injury caused by the incorrect installation of the touchscreen conducted by third parties. Damage to the touchscreen, caused by incorrect installation by third parties is not covered by the warranty. Always contact Prowise or a certified partner if you have any questions about the installation.



**WARNING!** Disconnect the power cable during thunderstorms. For extra safety, we recommend using a surge protector to prevent the touchscreen from sustaining damage as a result of power surges or lightning strikes.

## 2.3. Cabling

Use only the Prowise certified power cable to connect the Prowise Touchscreen to a grounded outlet. The touchscreen must be placed close to the electrical outlet, and the electrical outlet should be easy to reach. Cables should not be placed in the walkway to avoid anyone stepping on them or tripping over them. To avoid damage to the cables, do not place any objects on the cables. Prevent electrical overloads when using a distributing plug, as this can lead to a short circuit. For extra safety, we recommend using a surge protector.



**CAUTION!** Only plug the power cable into grounded electrical outlets with AC 100–240V ~ 50/60Hz. If you are not sure about the power supply at the installation location, contact the energy supplier.



**CAUTION!** Turn off the touchscreen completely when moving the screen by turning off the power switch and disconnecting the screen's power cable.

## 2.4. Installing Wi-Fi antennas

The Prowise Touchscreen is equipped with internal Wi-Fi. Follow the steps below to install the Wi-Fi antennas.

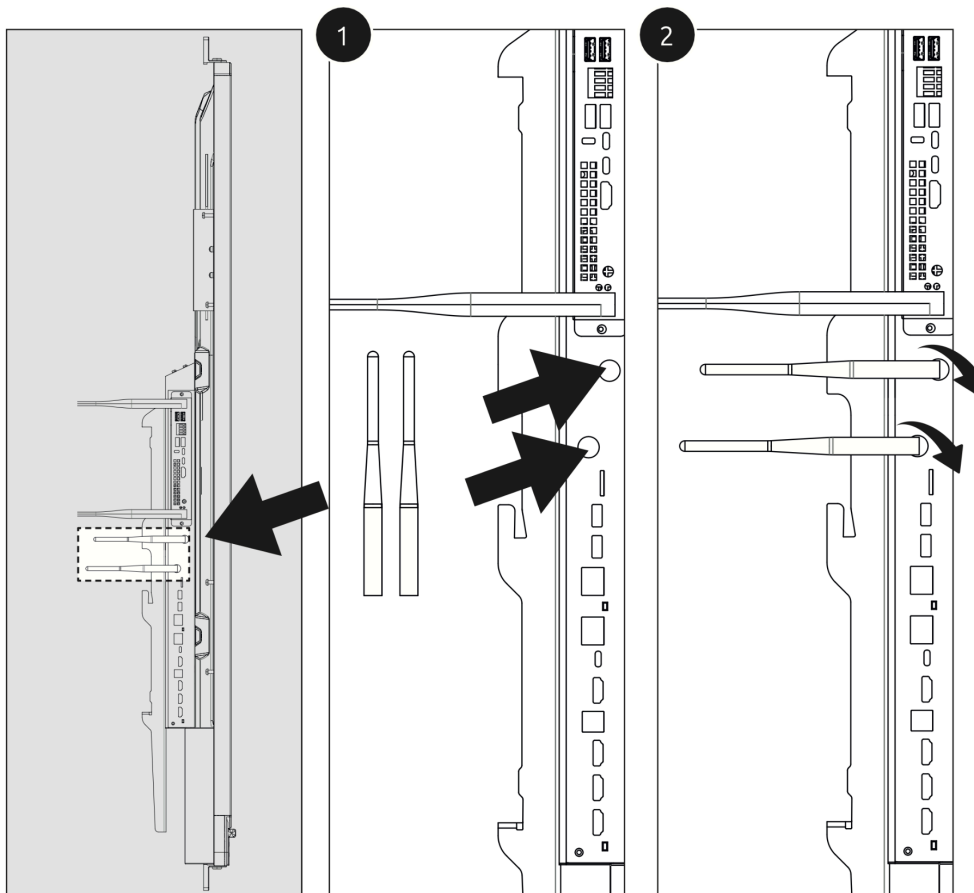

## 2.5. OPS module



**WARNING!** Make sure the power cable of the Prowise Touchscreen is disconnected before installing the module.



**CAUTION!** Using an OPS PC module will increase power consumption.

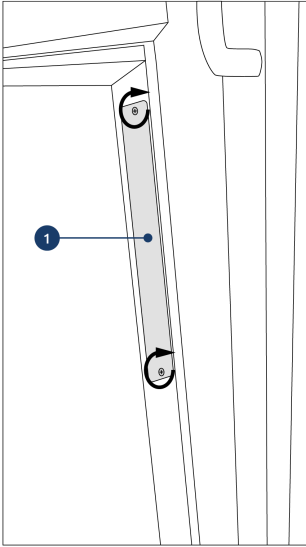

1. Unscrew the screws

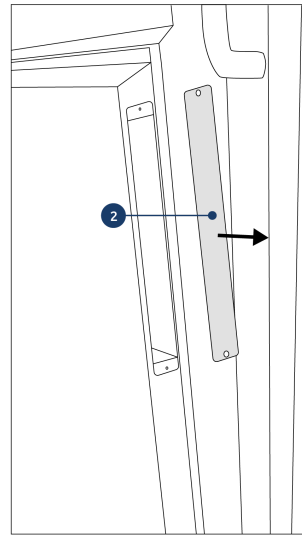

2. Remove the cover plate

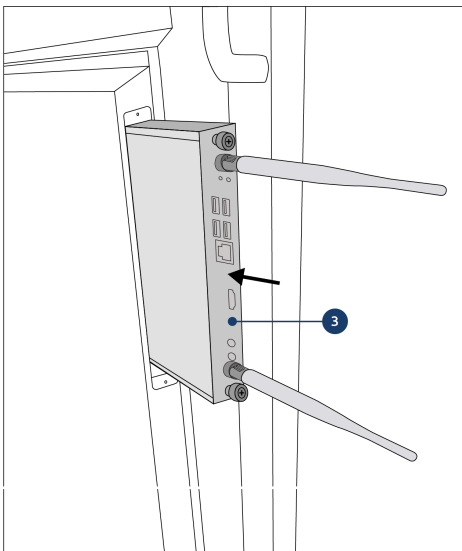

3. Insert the OPS PC module into the slot. Make sure the ventilation openings of the PC module correspond with the ventilation openings in the rear panel of the screen.

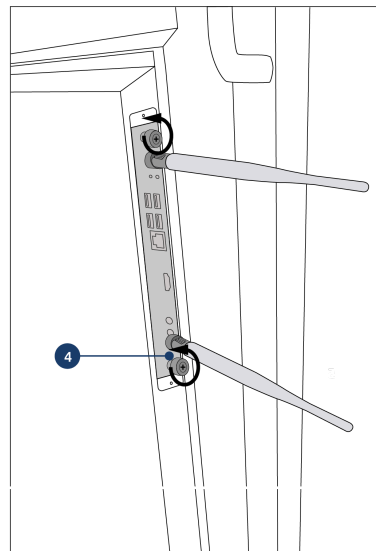

4. Tighten the PC module locking screws

## 3. Starting up the Prowise Touchscreen for the first time

### 3.1. Turn on the touchscreen

#### Enable

- Ensure the touchscreen is connected to the mains power supply.
- Turn on the power switch on the right side of the touchscreen.

There are a number of options to turn on the touchscreen after the power switch is activated:

- Press the on/off button located on the button panel on the left corner of the touchscreen
- Press the on/off button of the supplied remote control
- Via RS232
- If the proximity sensors are switched on and they detect movement, the screen will turn on automatically.

The control button can be found left of the speaker bar of the touchscreen.

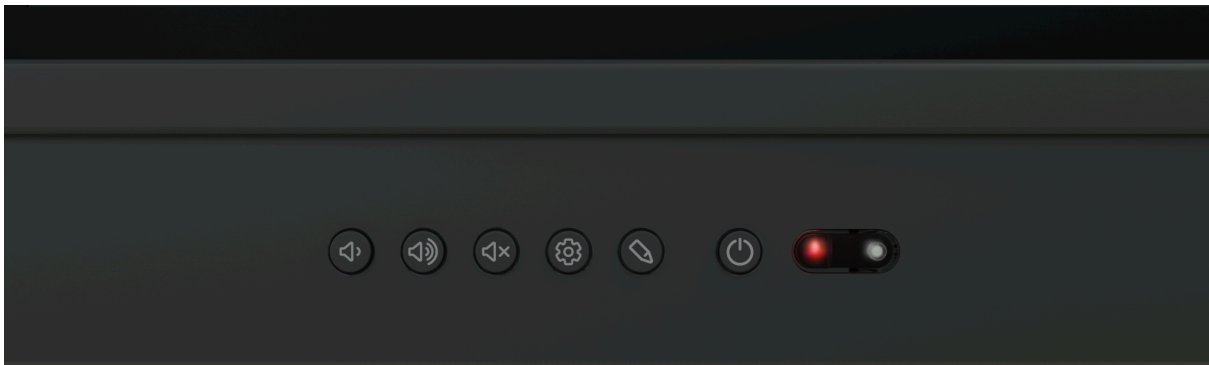

The LED in the bottom-left corner indicates the status of the touchscreen.

- Touchscreen is on: green
- Backlight is switched off: green
- Sleep mode: flashing red (every 2 seconds)
- Standby mode: red

## Disable

1. Press the on/off button in the touchscreen button panel for a few seconds or the on/off button of the remote control.
2. The notification 'The system will shut down in 10 seconds' will appear.
3. Select 'Shut down' if you want to shut down the touchscreen immediately or wait 10 seconds. Press 'Cancel' to cancel the shut-down process.
4. Switch off the main power supply using the power switch on the right side of the touchscreen (see image).

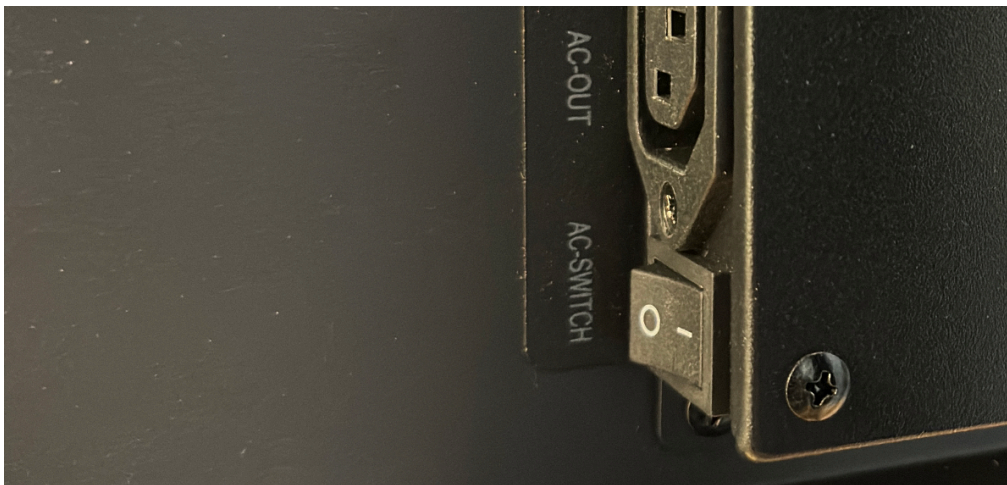

## Shut down automatically

When no active input source has been detected in a specific input channel, the touchscreen will show a shutdown notification after 3 minutes. This notification will be automatically accepted by the system after 10 seconds and the touchscreen will shut down. If the proximity sensors are enabled, the screen will close after a certain time if the sensors do not detect movement.

## 3.2. Complete installation

The first time you start your touchscreen, a set-up guide will open to help you configure the most important settings. Follow the steps below to complete the setup:

1. Ensure the touchscreen is connected to the mains power supply.
2. Turn on the power switch.
3. Press the on/off button (control button or remote control).
4. The touchscreen will turn on and the setup guide will appear.
5. Follow the steps on the touchscreen to finish the installation process.

6. The welcome screen will appear and the Prowise Central environment will open right after that.
7. You can now get started with your Prowise Touchscreen.

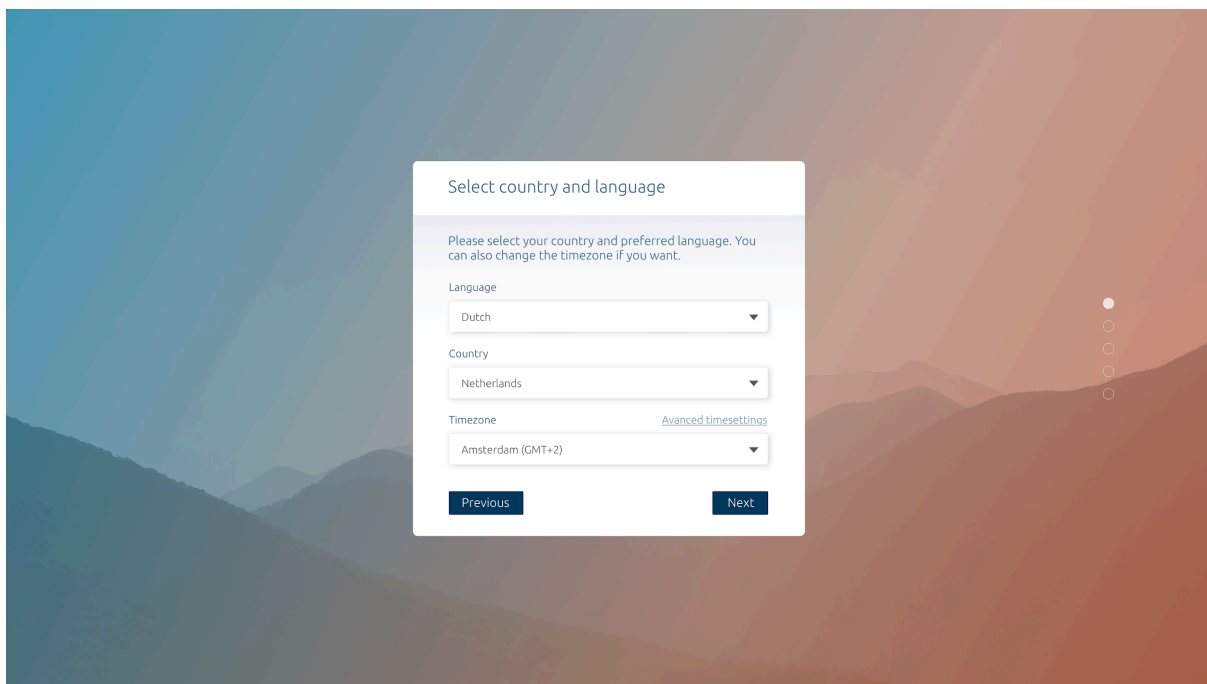

### 3.3. Connecting to a network

You can also connect your touchscreen to the internet after you have worked through the set-up guide. Connect your touchscreen to a wireless Wi-Fi network or via a network cable. You can find the settings in the Prowise Central settings menu

#### Ethernet

Connect the network cable to one of your touchscreen's LAN in ports. The touchscreen will automatically detect the network and connect to it as soon as 'Ethernet' has been activated in the settings menu.

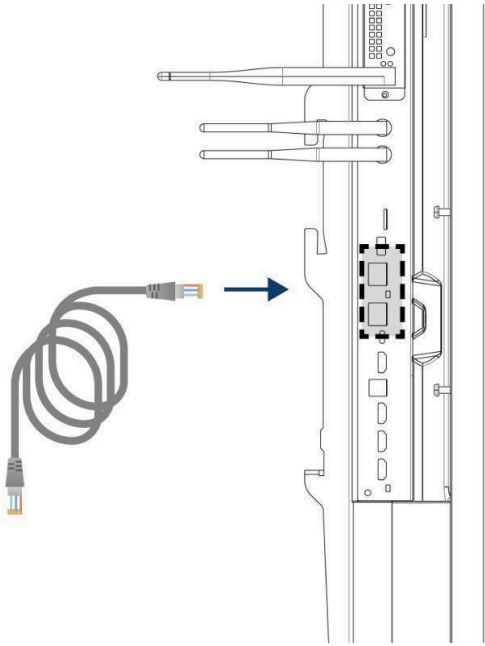

Follow the steps below to view the specifications of the network:

1. Open the Central settings menu by pressing the hamburger icon (three horizontal bars) in the quick menu and then selecting 'Settings'
2. Select the submenu 'Connectivity'
3. Select 'Ethernet' by activating the toggle
4. The network specifications will be displayed

You can easily loop the LAN connection by using the display's other LAN out port. Note that the LAN connection can only be looped when the screen itself is connected with a LAN cable and switched on. When a device is connected to the LAN port, it will have its own IP and MAC address.

## Wi-Fi connection

Connect to a Wi-Fi network as follows:

1. Check that the Wi-Fi antennas are correctly installed
2. Open the Central settings menu by pressing the hamburger icon (three horizontal bars) in the quick menu and then selecting 'Settings'.
3. Select the submenu 'Connectivity'
4. Select 'Wi-Fi'. The touchscreen searches for available networks.
5. Choose the preferred network. Click the 'Advanced' button to connect to an advanced network.
6. Enter the password for the network. Press the eye icon to display the characters of the password.
7. Press the 'Connect' button to connect to the wireless network

## Bluetooth

1. Open the Central settings menu by pressing the hamburger icon in the quick menu and then selecting 'Settings'.
2. Select the submenu 'Connectivity'
3. Click 'Bluetooth'
4. Activate the Bluetooth toggle
5. Select a Bluetooth device
6. Press 'Connect' to connect to a device via Bluetooth

## 4. Your Prowise Touchscreen in everyday use

### 4.1. The right position

Always adjust the screen to the correct height before use. Avoid standing in a stooped or bent posture and ensure that the ends of the screen are located within arm's reach. The screen is in an optimal position if you can touch both the top and the bottom without bending down or reaching up high. By placing the screen at the right height, you can avoid physical problems that can result from incorrect working posture.

Prowise recommends using the touchscreen in combination with a Prowise Lift System to ensure the correct height and position of the screen at all times.



The Prowise iPro lift systems are connected to the USB 2.0 port on the screen through a USB cable. This enables you to operate the lift via the screen and configure presets.



**DANGER!** Injury risk. Do not stand on a chair, stool or other object to operate the touchscreen. This especially applies to children! This involves a risk of falling that could result in serious injury. Make sure the screen is installed at the correct height or that the lift is set to the correct height when the screen is used.

## 4.2. Touchscreen operation

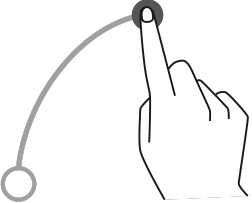
Prowise Touchscreens are equipped with 40 touch points. This allows you to use the touchscreen with multiple people at once.

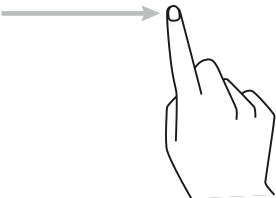
	Click	To click on any part of the screen, tap the touchscreen with one finger.
	Drag	With one finger, tap on the item that you want to move and drag it to the new location without releasing your finger from the screen.
	Right-click with the mouse	Tap and hold a finger on the screen for several seconds.
	Scroll	Slide a finger across the screen in the desired direction.

The touchscreen can also be operated using a computer mouse (if connected), the supplied remote control or the optional Prowise Magic Remote.

## 4.3. Pens

The Prowise Touchscreen is equipped with two pens. This makes it possible to simultaneously write with two different colours and erase things with the palm of your hand in Prowise Teach, among others.

## 4.4. Prowise Central

Prowise Central is the smart operating system of your Prowise Touchscreen.

### Quick menu

On the left-hand side of the Prowise Touchscreen Ten G3 SE, three icons are always displayed, which we call the quick menu.



- Teach icon: open Teach, the integrated whiteboard software
- Home icon: takes you to Prowise Central home
- Three bars (hamburger menu): this opens the Prowise Central menu

### Menu

You can open the Prowise Central menu in three ways.

1. Press the three bars on the left or right side of the screen
2. Briefly press the control button in the middle, at the bottom of the touchscreen
3. Press the Prowise eye on the remote control
4. Place five fingers on the screen for a few seconds

The Prowise Central menu consists of the following items:

- Login: to log into your Prowise Central environment, your touchscreen must be managed in Prowise Screen Control.
- Active apps: see which apps are active on your touchscreen and close the active ones.
- Screencasting: information on screencasting protocols. Here it is also possible to activate or deactivate certain protocols.
- Input sources: switch between different input sources.
- Volume: turn the volume up or down.
- Lift control: raise or lower the connected lift and manage presets (if a Prowise lift system is connected to the screen).
- Settings: go to the extended settings menu.
- Off button: switch off the touchscreen.

## Settings

Click 'Settings' to view the extended settings menu. For more information, we would like to refer you to our Prowise Central manual.

### General

- Audio
- Display
- Input
- Remote control
- Localisation
- Energy
- Security
- Advanced

### Theme

Change the screen background

### Connectivity

- Wi-Fi
- LAN
- Bluetooth

### About this screen

Relevant screen information including serial number, Prowise Central version, etc.

### Legal

Legal information regarding certifications, conditions and privacy.

### OTA Updates

OTA updates (over-the-air updates) ensure that you always have the latest software version installed on the touchscreen. The only thing you need for the OTA updates is an internet connection with Prowise Central. This can be a Wi-Fi or Ethernet connection.





Check for available software updates:



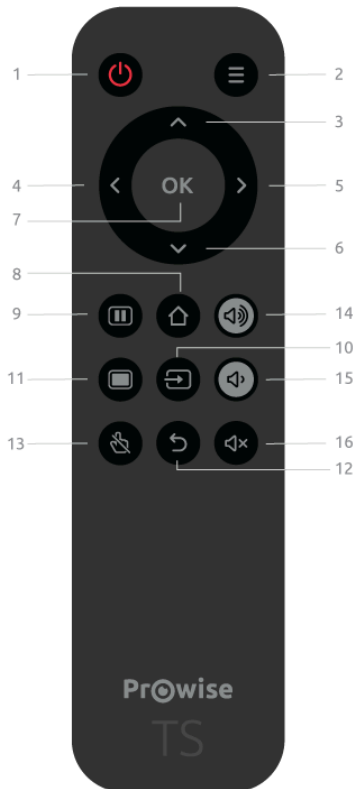







- Go to 'Settings'
- Select 'About this screen'
- Click on 'Check for updates'

- Press 'Update' to execute the update
- The screen shuts down automatically to complete the update and can be turned on again if so desired.

## 4.5. Remote control



1		Press this button to turn the touchscreen on or off. Then press the Enter button to confirm the off command.
2		Open the Prowise Central menu
3		Navigation button - up
4		Navigation button - left

5		Navigation button - right
6		Navigation button - down
7	Ok	Confirm selection
8		If an input other than Prowise Central home is active, this button can be used to return to the Prowise Central home.
9		Freeze display
10		Open the input source selection from Prowise Central
11		Turn off the screen temporarily. This is depicted in the form of a black screen. Programmes will remain active in the background.
12		Go back one step. If the Central menu is active, this closes the menu.
13		Enable or disable the touch function.
14		Increase the volume level
15		Lower the volume
16		Switch the touchscreen's internal speakers on or off.

Point the remote control at the infrared receiver of the touchscreen (bottom-left-hand side of the screen). The remote control has a range of around 8 metres.

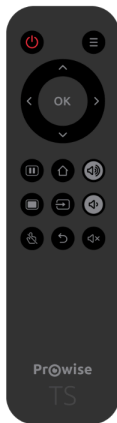
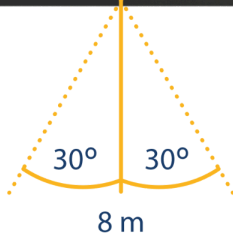

**CAUTION!** If there are obstacles between the remote control and the touchscreen receiver, the remote control may not work correctly.

## Replacing the batteries of the remote control

Before using the remote control for the first time, you need to place the supplied (1.5V AAA) batteries into the remote control. Once the batteries are running out and the remote control is no longer working properly, you must change the batteries. You can do this as follows:

1. Carefully remove the cover plate on the back side of the remote control.
2. Insert two batteries (1.5V, AAA) in the remote control.
3. Place them with the positive and negative poles as indicated by the (+) and (-) signs in the battery compartment.
4. Close the battery compartment again by carefully placing the cover plate back.

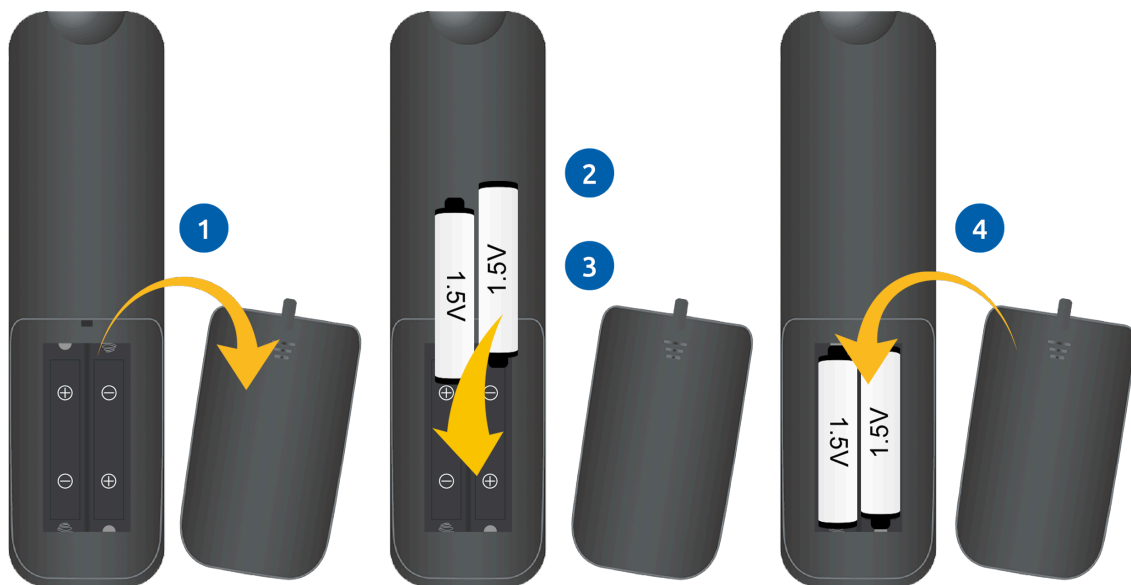

**WARNING!** Remove any leaking batteries from the remote control as soon as possible. Thoroughly wash your hands afterwards. The leaking chemicals are toxic and should never come into contact with the mouth, skin or eyes.



**CAUTION!** Use only 1.5V AAA batteries. Insert them as shown in the instructions on the remote control.

## 4.6. Sensors

Various sensors are implemented in the bottom left-hand corner of the screen.

### IR Sensor

The remote control's infrared sensor is located here. Point the remote control towards this corner to make sure the signal is received correctly.

### Light Sensor

The light sensor that determines the brightness of the screen is located here (if enabled). The brightness of the screen will be adjusted by means of this light intensity.

### Motion sensor

On the Prowise Touchscreen you will find one motion sensor, in the bottom right corner. These environmental sensors reduce power consumption and thus environmental impact by preventing the screen from being left on unnecessarily. The automatic switch-off function is activated when no motion is detected for a preset number of minutes. As soon as any movement is detected in the space, the screen will automatically start up. This ensures a better user experience. Caution! It takes a few seconds for the screen to automatically start up from standby mode. The motion sensor detects when someone is in the room, at a distance of three metres from the screen, and can trigger an automatic start or shut-off function. This feature can be set in the distribution menu for IT administrators.

## 4.7. Cleaning

Clean the screen with a dry, lint-free, microfibre cloth. Ensure this cloth is clean. If you want to use a cleaning product, always use a cleaning product recommended by Prowise, such as the Prowise Screen Cleaning Kit. Do not use any aggressive cleansers as these can cause damage to the screen. Make sure the cleaning agent has an alkaline pH value between 7 and 9, otherwise the glass pane or the screen may be damaged. Never use a cleaning agent with a PH value higher than 9 or lower than 7.

Never spray a cleanser directly onto the screen, apply it to a cloth first. The cloth may be slightly damp, but not wet, as this can cause damage to the screen.

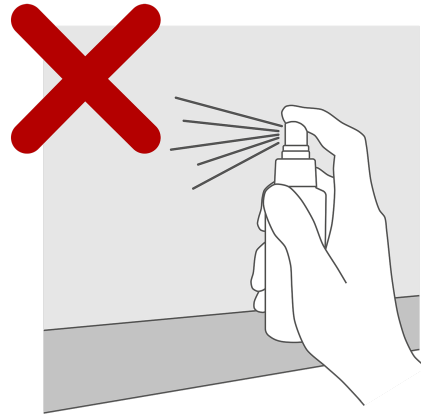
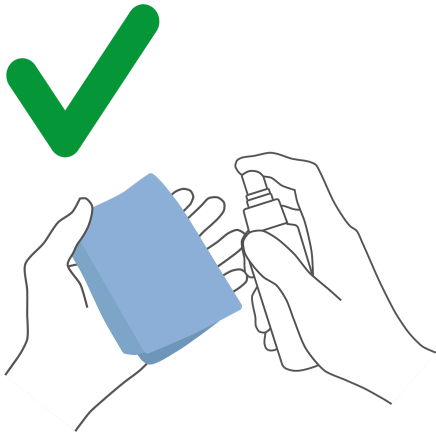

Gently wipe the screen with a cloth. For the best result, clean the screen by making gentle, circular movements without applying too much pressure. Never use an abrasive cleanser.



**WARNING!** In case the touchscreen gets wet, do not switch on the touchscreen and do not plug the power cable into the socket. This can result in an electric shock. Should the touchscreen get wet while it is turned on, immediately turn off the power supply and disconnect the power cable of the touchscreen from the electrical outlet to avoid a short circuit.



**CAUTION!** Disconnect the power supply before cleaning the screen.

## 5. Connecting auxiliary equipment

### 5.1. HDMI

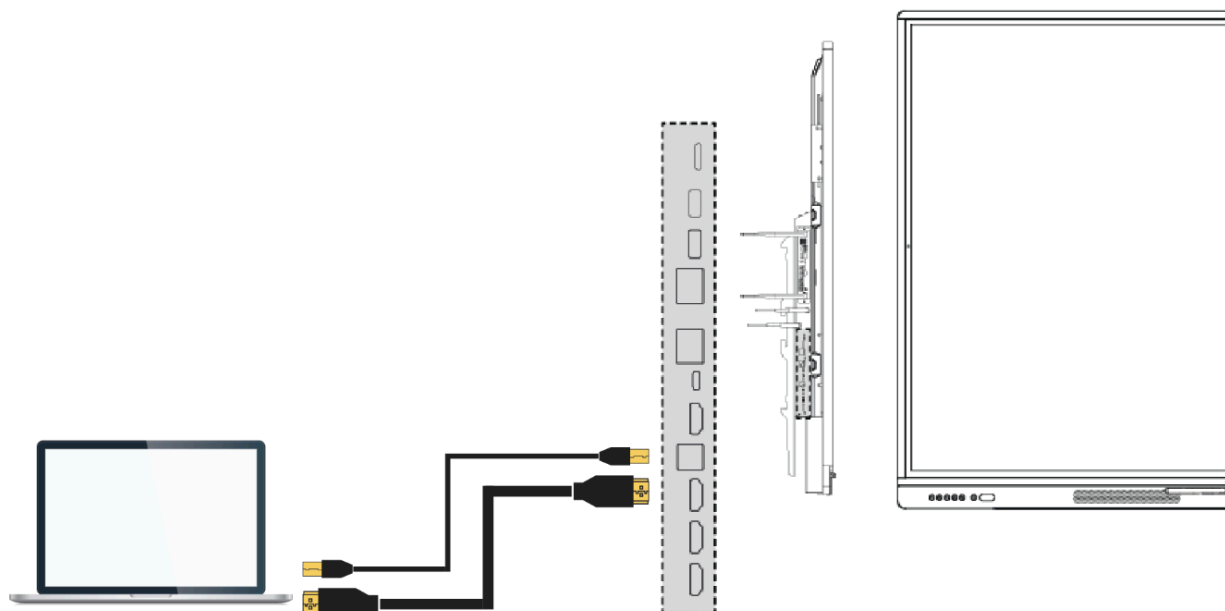

To ensure that your device, such as a laptop or desktop PC, can also be operated through touch on the touchscreen, a USB touch cable must be connected (USB-B to USB-A) in addition to a wired connection for video and audio. The advantage is that you do not have to keep walking to your device to operate it and can teach from the touchscreen. The USB touch port is located right by the HDMI ports. Make sure the correct USB touch port is used when connecting a device.

1. Connect an HDMI cable to the HDMI port of the external PC and to the HDMI input port of the touchscreen.
2. Connect the USB touch cable to the touchscreen's USB touch port and to a USB port on the external PC.
3. Once all the cables have been connected, switch on the touchscreen and the external PC.
4. Once the touchscreen and the external PC have started up, navigate to 'Input' in the Prowise Central menu and select the appropriate HDMI source.



**CAUTION!** We recommend using the shortest possible cable (<5 metres) of good quality for the best connection quality.

## 5.2. USB-C

The screen's full-function USB-C port has different functions. Through this port, image, sound, touch, data, internet and up to 100W power can be transferred simultaneously, this is enough to power your laptop. Connect your device to this port with a USB-C cable to get started straight away with only one cable. The USB-C port supports the following protocols:

- USB 3.0
- Video (DP 1.2, 3840x2160 @ 60Hz)
- Audio
- Touch (USB 3.0)
- Power (20V/5A/up to 100W)
- LAN 100 Mb/s



**CAUTION!** Make sure the USB-C cable is of good quality and not too long to establish a good connection.



**CAUTION!** Data transfer via the USB-C port only works in Prowise Central. This is because this port does not forward to other input sources (the USB-C port supports storage devices up to 16TB).

## 5.3 VGA

You can also connect an external device with the Prowise Touchscreen via VGA cable. Please note: this only enables a video connection. The audio signal is provided via a 3.5mm jack plug (stereo) on the PC Audio In port and Touch via the accompanying USB touch port.

1. Connect a VGA cable to the VGA port of the external PC and the VGA port of the touchscreen.
2. Then connect a 3.5mm jack plug to the PC audio in port.
3. If you also want to support the touch function, also connect a USB touch cable (USB-B to USB-A)
4. Once all the cables are connected, switch on the touchscreen and the external device.
5. Once the touchscreen and the external PC have started, navigate the Prowise Central menu to 'Input' and then select the VGA source.

## 5.4. Connecting the Prowise touchscreen to audio devices

### 5.4.1. Connecting headphones

Connect headphones by plugging them into the analogue audio output “headphones”. Use the touchscreen’s volume control to adjust the headphones volume.

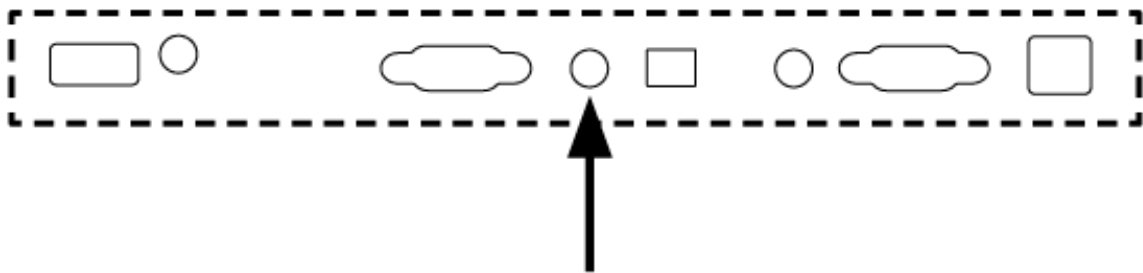

## 5.4.2. Connecting an amplifier

Connect an amplifier by connecting it to the digital optical SPDIF port. Use the amplifier's volume control to adjust it.

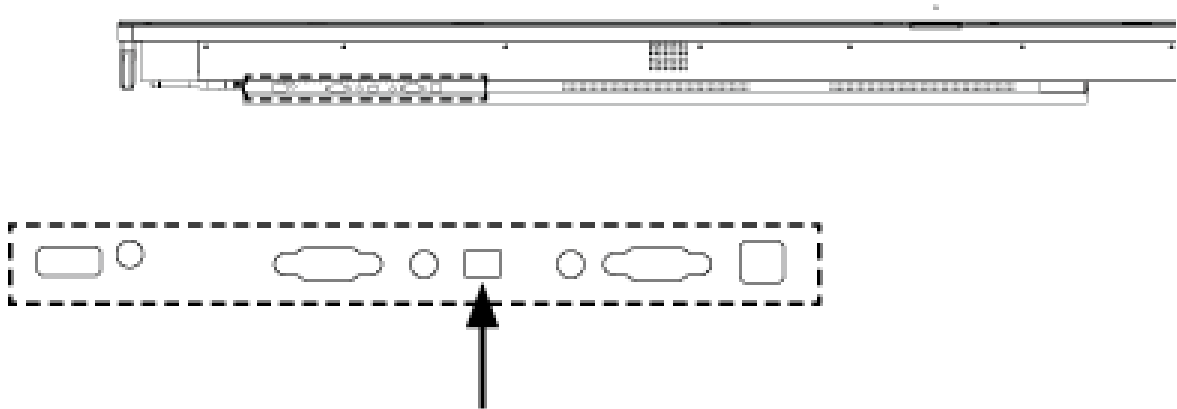

**CAUTION!** The audio output (the digital SPDIF audio port) is always active. If you connect an external audio device to the touchscreen and want to use only this audio device, press the 'Mute' button on the remote control or in the Central menu to turn off the touchscreen's internal speakers.

## 5.4.3. Connecting a microphone

Connect a microphone using the microphone port at the bottom of the screen. The microphone will act as an amplifier in combination with the display's speakers.

Keep enough distance between the screen and the microphone to avoid a feedback loop.

## 5.5. Connecting via the HDMI port (ARC)

It is possible to connect an external audio device using an ARC (Audio Return Channel) connection. This allows the external audio device to be controlled via the touchscreen. To connect an audio device via ARC, insert one end of an HDMI cable into the HDMI port of the ARC-enabled touchscreen and the other end into the HDMI port of the external audio device.

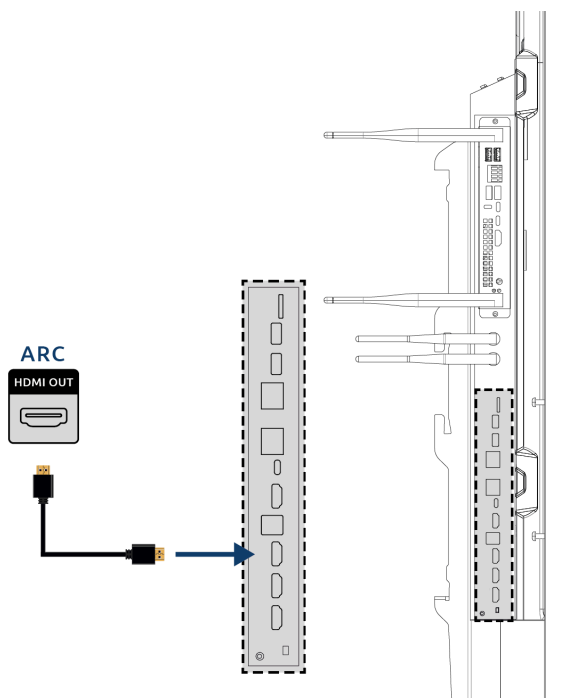

## 5.6. Microphone and camera passthrough

Microphone and camera passthrough allows you to redirect your microphone and camera input on the touchscreen to your personal device. This allows you to easily join calls via Skype, Teams, Zoom, Google Meet, etc.

Technical

- Your personal device must be connected to the USB touch or USB-C port.
- Make sure the USB cable is relatively short; we recommend a length of 3 to 5 metres.

## 5.7. Connecting via the HDMI port (CEC)

CEC (Consumer Electronics Control) is a functionality that works via HDMI. The devices that are connected to each other in this way communicate via CEC. This allows these devices to be controlled via the touchscreen's remote control.

Connect a device through CEC by plugging an HDMI cable into the touchscreen's HDMI port.

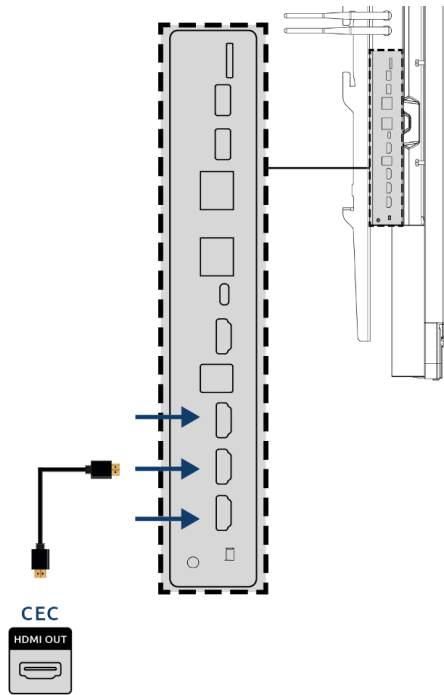

## 5.8. Using an SD card

To expand the screen's storage capacity in the Prowise Central environment, you can use an SD card that can be installed in the SD card slot. This is also an easy way to have files ready on your screen that are not online.

Caution! The SD card slot supports SD cards up to 128GB (FAT32).

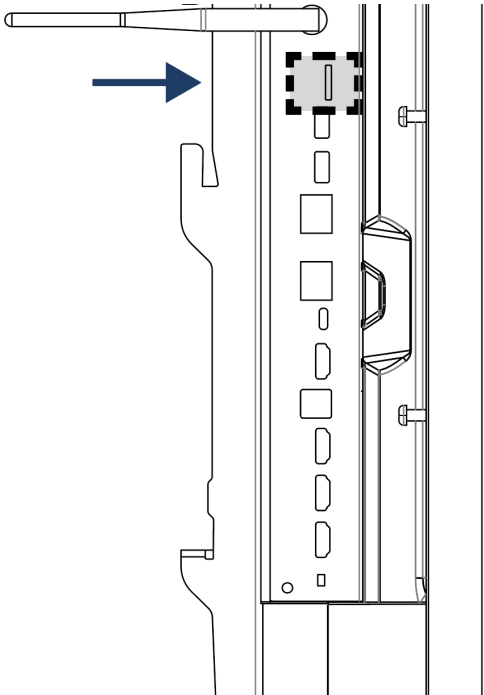

## 6. Important safety instructions



**WARNING!** Please read this user manual and the safety instructions (separate document) carefully before using the Prowise touchscreen. Adhere to the warnings on the device, in the user manual and in the safety instructions. Always keep the safety instructions and user manual within reach.

If the device is used for purposes other than those stated in the safety instructions and user manual, Prowise B.V. is in no way liable for material damage and/or injury. Do not make changes to the device without written permission from Prowise. Improper use will void the warranty.

### 6.1. Safety

- Never open the housing of the touchscreen! You can get an electric shock or cause short circuiting.
- Do not use the touchscreen during thunderstorms and unplug the power cable to avoid damage due to a lightning strike.
- Make sure your touchscreen does not get wet! This could lead to a short circuit and electrocution hazard. Do not install the device close to water and do not place objects containing liquid on or next to it.
- A high volume level can cause permanent hearing damage. If the device is used at high sound volume for an extended period of time, it can cause hearing damage to the listener.
- Use only the components and accessories supplied by Prowise.

- Always turn off the touchscreen and unplug it from the electrical outlet when changing a module.
- Do not insert objects into the openings of the touchscreen that are not intended for this purpose. This can cause short-circuit or even fire.

## 6.2. Repairs

Never repair the touchscreen yourself! Repairs carried out by third parties or unauthorised persons will void the warranty.



**WARNING!** Warning for electrified parts! Never open the housing of the touchscreen! You can get an electrical shock, cause short circuiting or even a fire. This may cause injury or damage to yourself and/or the touchscreen.

Always contact Prowise or a certified partner in case of a defect, to avoid damage. Contact information can be found at: [www.prowise.com](http://www.prowise.com)

## 6.3. Environment

- Unplug the power cable if the screen will not be used for an extended period of time.
- The power consumption in standby mode is <0.5 watts.
- The Prowise Touchscreen is ENERGY STAR-certified.
- When the touchscreen is no longer usable, it can be disposed of at a designated collection point.



**CAUTION!** When WOL (wake on lan) and WOS (wake on source) are activated, power consumption increases in standby mode!

## 6.4. Recycling and disposal

For questions about the correct disposal of your touchscreen, please contact Prowise or an authorised partner.



### Packaging

The device is packaged to prevent transport damage. Packaging is made of resources that can be reused or recycled.



### Device

Do not dispose of the device together with the household waste at the end of its lifespan. Enquire about the possibilities for an environmentally friendly and responsible method of disposal.



### Batteries

Depleted or defective batteries do not belong in the household waste. Dispose of them at a collection point for empty batteries. The remote control uses 1.5V AAA batteries.