

Required tools

- Hex key 4 + 6
- Philips PH 2
- Ring spanner 10

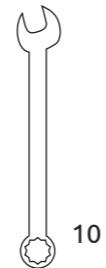

Assembly Manual Prowise Mobile lift

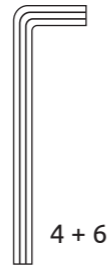
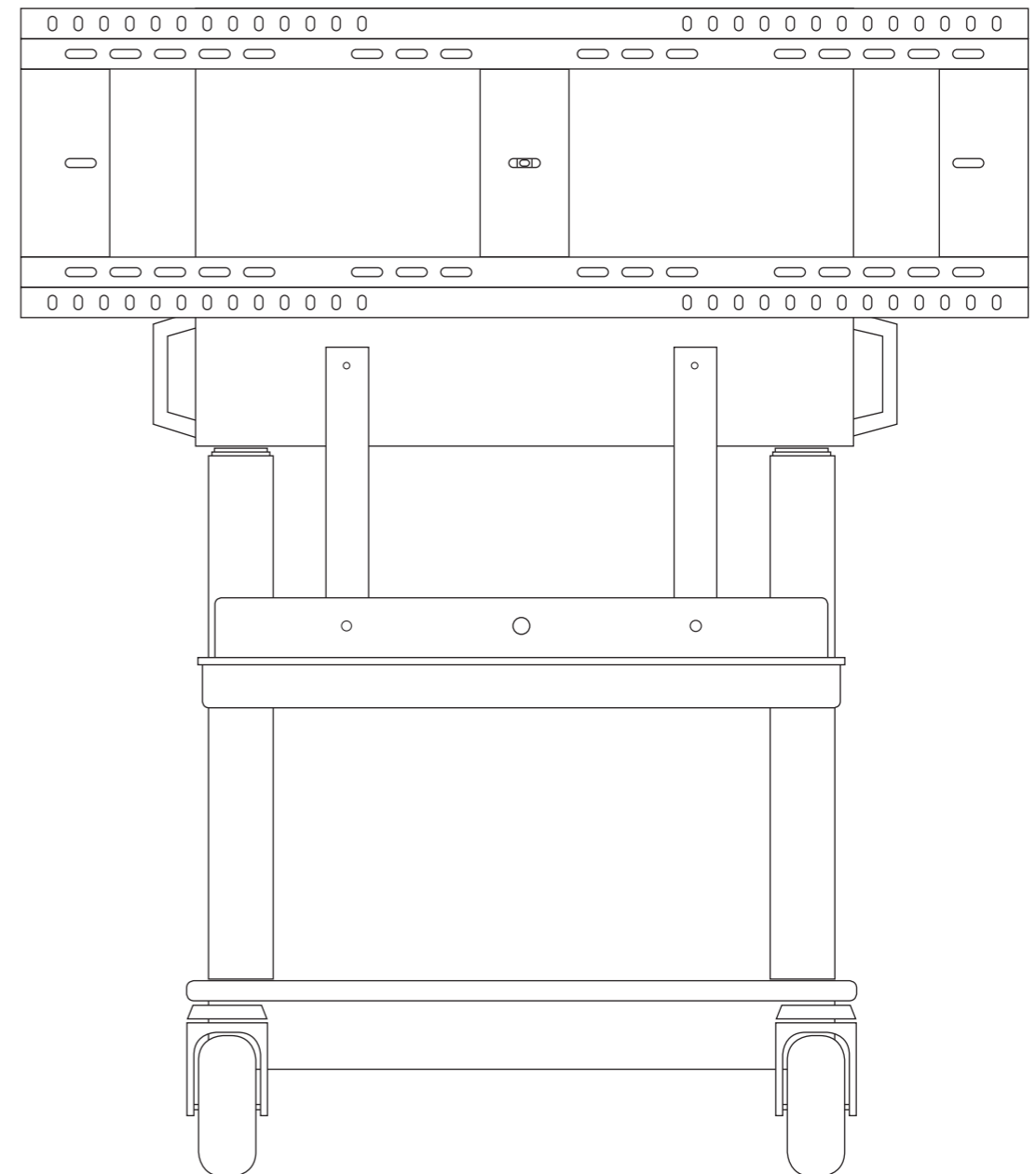

Prowise

Prowise B.V.
Luchthavenweg 1b
6021 PX Budel
The Netherlands
Tel. +31 495 49 71 10
info@prowise.com

www.prowise.com

© Prowise 2014

Included

- A • Cable housing with:
 - VESA bracket
 - Control unit
 - Controller
 - Power strip

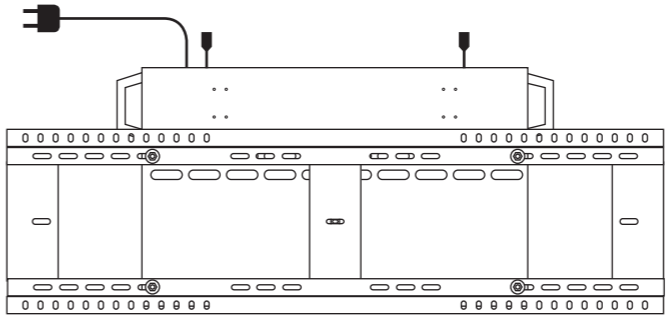

- B Back plate for cable housing
 - 6 x M5x8 bolts (PH2) for assembling back plate to the cable housing

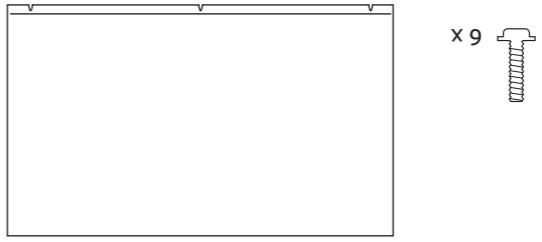

- C Chassis assembled with 4 wheels and 2 height adjustable pillars.
 - 8 x M6x16 bolts for assembly of the cable housing

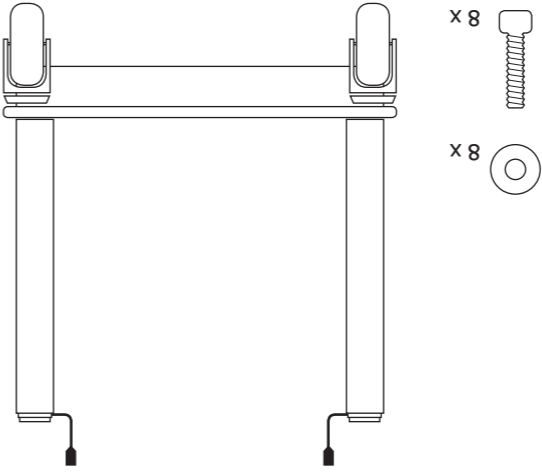

- D Tubes for assembly of the keyboard tray
 - 4 x M6x35 for assembly on VESA bracket



- E Keyboard Tray
 - 2 x M6x35 for assembly on tubes

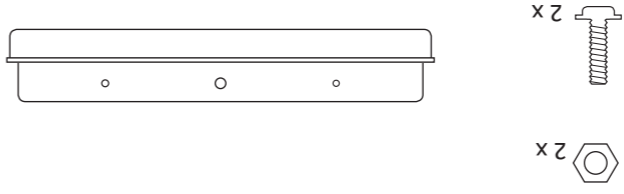

- F 2 mounting braces for assembly Prowise multi-touchscreen
 - 4 x M8x20 bolts and 4 x M8 washers
 - 2 x M5x10 bolts to secure mounting braces on VESA bracket

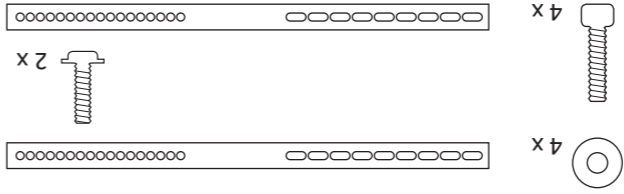

Please only use supplied parts

Assembly instructions

